



Model Part No.:
1071118

Scout™ 5

TwinMax™ Technology

Tennant True® Parts

Battery Powered Push Sweeper

Barredora eléctrica

Balayeuse autotractée alimentée par batterie

Operator and Parts Manual **EN**

Manual de funcionamiento y lista de componentes **ES**

Manuel de fonctionnement et liste des pièces **FR**

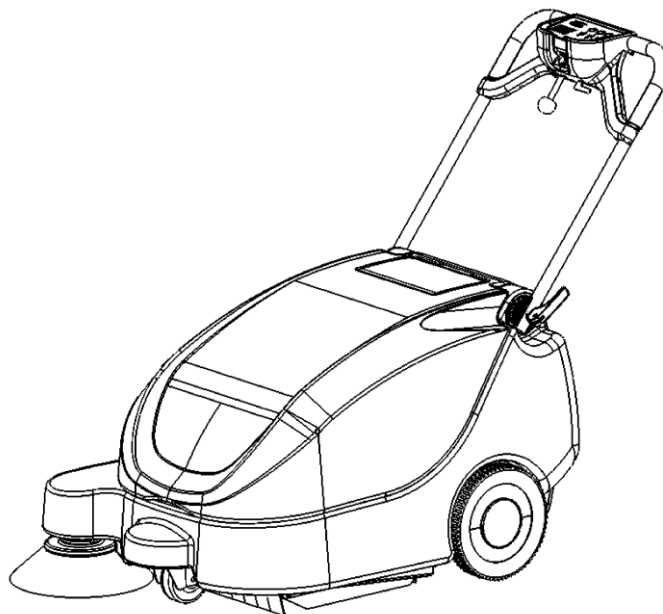

Introduction

This manual is furnished with each new model. It provides necessary operation and maintenance instructions and replacement parts information.



Read all instructions before using this machine.

Intended Use

This battery powered push sweeper is intended for commercial use, for example in buildings, warehouses, parking lots and sidewalks. It is designed for indoor and outdoor use and suitable for picking up dry, nonflammable dust and debris on dry hard floor and carpet surfaces. It is not suitable for wet surfaces or for picking up flammable or hazardous materials.

General Information

This machine will provide excellent service. However, the best results will be obtained at minimum costs if:

- The machine is operated with reasonable care.
- The machine is maintained regularly - per the machine maintenance instructions provided.
- The machine is maintained with manufacturer-supplied or equivalent parts.



Protect the Environment

Please dispose of packaging materials and used machine components in an environmentally safe way according to local waste disposal regulations.



Always remember to recycle.

Technical Specifications

Model	Scout 5
Length	923 mm / 37 in
Width	650 mm / 25 in
Height	557 mm / 22 in
Weight	55 kg / 121 lb
Sweeping Path Width	620 mm / 24 in
Main Brush Width	400 mm / 16 in
Side Brush Diameter	300 mm / 12 in
Hopper Capacity	37 L / 9.8 Gal
Battery Capacity	12 V, 50 Ah
Total Power Consumption	12 VDC, 230 W, 12.6 A
Battery Charger	100-240VAC 8A
Productivity Rate (Net)	1290 m ² /hr / 13850 ft ² /hr
Slope Maximum	2%
Machine Vibration at Hand-arm *	<2.5m/s ²
Machine Vibration Uncertainty K *	0.8 m/s ²
Sound Pressure Level L _{PA} *	62 dBA
Sound Uncertainty K _{PA} *	3 dBA
Sound Power Level L _{WA} + Uncertainty K _{WA} *	81 dB(A)
Protection Grade	IPX3
Operation Temperature	min. -15°C, max. 40°C

* Values determined as per EN 60335-2-72

Tennant Company
 PO Box 1452, Minneapolis, MN 55440 USA
 Phone: (800) 553-8033 or (763) 513-2850
 www.nobles.com

Original Instructions. Copyright © 2012 TENNANT Company.
 All rights reserved. Printed in Germany.
 Specifications and parts are subject to change without notice.

Machine Data

Please fill out at time of installation for future reference.
 Model No. - _____
 Serial No. - _____
 Installation Date - _____

IMPORTANT SAFETY INSTRUCTIONS (SAVE THESE INSTRUCTIONS)



This symbol warns the operator of hazards and unsafe practices which could result in severe personal injury or death.



WARNING: To Reduce the Risk of Fire, Explosion, Electric Shock, or Injury:

- Do not use near flammable liquids, vapors or combustible dusts.

The machine is not equipped with explosion proof motors. The electric motors will spark upon start up and during operation which could cause a flash fire or explosion if machine is used in an area where flammable vapors/liquids or combustible dusts are present.

- Do Not Pick Up Flammable or Toxic Materials and Burning Debris.
- Batteries Emit Hydrogen gas. Keep Sparks and Open Flame Away When Charging Batteries.
- Charge batteries in a well ventilated area.
- Disconnect Battery Cable and Charger Cord Before Servicing.
- Do Not Charge Batteries with Damaged Cord. Do Not Modify Plug.
- Do Not Use On Wet Surfaces. Store Indoors.

The following safety precautions signal potentially dangerous conditions to the operator or equipment.

FOR SAFETY:

1. Do not operate machine:
 - Unless trained and authorized.
 - Unless operator manual is read and understood.
 - Unless mentally and physically capable of following machine instructions.
 - In areas that are too dark to safely see the controls or operate the machine.
 - If not in proper operating condition.
 - Without hopper and/or filter in place.
2. Before operating machine:
 - Make sure all safety devices are in place and operate properly.
3. When operating machine:
 - Use only as described in manual.
 - Do not pick up objects such as cords, strings, wires that may entangle brush.
 - Report machine damage or faulty operation immediately.
 - Do not leave unattended or on an unlevel surface.
 - Do not allow children to play on or around machine.
 - Keep children and unauthorized persons away from machine when in use.

- Go slow on slippery surfaces.
 - Do not operate on inclines that exceed 2 %.
 - Do not use machine to transport people or objects.
 - Wear a dust mask, protective glasses and gloves in dusty environments.
 - Keep hands away from spinning brush.
 - Use caution when lifting full hopper to avoid back strain.
 - Wear heavy gloves when removing sharp objects from hopper.
 - Turn machine power off if brush becomes obstructed or machine malfunctions.
- 4. Before leaving or servicing machine:**
- Stop on level surface.
 - Turn the main power button to the off position.
- 5. When servicing machine:**
- Turn the main power button to the off position.
 - Disconnect battery cable and charger cord before working on machine.
 - Wear protective gloves and glasses when handling batteries or battery cables.
 - Avoid contact with battery acid.
 - Use manufacturer supplied or approved replacement parts.
 - All repairs must be performed by a qualified service person.
 - Avoid moving parts. Do not wear loose clothing or jewelry and secure long hair.
 - Do not power spray or hose off machine near electrical components.
 - Do not modify the machine from its original design.
 - All work must be done having enough visibility and/or appropriate lighting.
 - Wear personal protective equipment as needed.
- 6. When transporting machine:**
- Turn the main power button to the off position.
 - Get assistance when lifting machine.
 - Use a loading ramp that will support the weight of the machine.
 - Do not wheel up or down stairs.
 - Use tie-down straps to secure machine when transporting by vehicle.

Onboard Battery Charger Information

The onboard battery charger's charging profile is specifically configured for a 12V sealed GEL battery. When installing a replacement battery it is important to use the same battery type or damage to the battery and/or charger may result.

For battery charger operating instructions, refer to the battery charger manual supplied with the machine.

Safety Label

The safety label appears on the machine in the location indicated. Replace label if missing, damaged or illegible.

⚠ WARNING	
	
TO REDUCE THE RISK OF FIRE, ELECTRIC SHOCK, OR INJURY: <ul style="list-style-type: none"> • Do Not Use Near Flammable Liquids, Vapors or Combustible Dusts. • Do Not Pick Up Flammable or Toxic Materials and Burning Debris. • Keep Sparks and Open Flame Away When Charging Batteries. • Disconnect Battery Cables and Charger Cord Before Servicing. • Do Not Charge Batteries With Damaged Cord. Do Not Modify Plug. • Do Not Use On Wet Surfaces. Store Indoors. 	
⚠ AVERTISSEMENT	
POUR RÉDUIRE LES RISQUES D'INCENDIE, DE CHOC ÉLECTRIQUE OU DE BLESSURE: <ul style="list-style-type: none"> • N'utilisez Pas Près de Liquides, Vapeurs ou Poussières Inflammables. • Ne Ramassez Pas de Matériaux Inflammables ou Toxiques et de Déchets Enflammés. • Éloignez les Sources d'Étincelles ou de Flamme Ouverte Lors du Chargement des Batteries. • Débranchez les Câbles de Batterie et la Cordon du Chargeur Avant l'Entretien. • Ne Chargez Pas la Batterie Avec un Cordon Endommagé. Ne Modifiez Pas la Prise. • N'utilisez Pas Sur des Surfaces Humides. Entrezposez à l'Intérieur. 	
⚠ ADVERTENCIA	
PARE REDUCIR EL RIESGO DE INCENDIO, CHOQUE ELÉCTRICO, O LESIONES: <ul style="list-style-type: none"> • No Use Cerca De Líquidos Flamables, Vapores Ó Materiales Combustibles. • No Recoja Materiales Flamables Ó Tóxicos Ni Desechos Candescentes. • Mantenga Chispas Y Fuego Alejados Mientras Carga Baterías. • Desconecte Cable De Batería Y Cable Del Cargador Antes Del Mantenimiento. • No Cargue Baterías Con Cable Dañado. No Altere El Enchufe. • No Lo Utilice En Superficies Húmedas. Guarde Bajo Techo. 	
1071275	



Introducción

Este manual se incluye en todos los modelos nuevos. Proporciona la información necesaria para su utilización, mantenimiento y cómo reponer las piezas.



Lea todas las instrucciones antes de utilizar esta máquina.

Uso previsto

Este cortacésped manual está pensado para su uso comercial en edificios, almacenes, aparcamientos y aceras, entre otros. Está diseñado para interior y exterior y además recoge el polvo y los restos de suciedad secos y no inflamables de los suelos secos y alfombras. No es apropiado para superficies mojadas o para recoger materiales inflamables o peligrosos.

Información general

Esta máquina ofrece un funcionamiento excelente. Sin embargo, los resultados serán óptimos a un coste mínimo si:

- Maneja la máquina con un cuidado razonable.
- Realiza las operaciones de mantenimiento regularmente y de acuerdo con las instrucciones adjuntas.
- Las operaciones de mantenimiento de la máquina se realizan con piezas suministradas por el fabricante o equivalentes.



Proteja el medio ambiente

Deseche el material de embalaje y los componentes usados de la máquina de forma segura para el medio ambiente, de acuerdo con las normas locales sobre desecho de residuos.



No olvide reciclar.

Especificaciones técnicas

Modelo	Scout 5
Longitud	923 mm / 37 in
Anchura	650 mm / 25 in
Altura	557 mm / 22 in
Peso	55 kg / 121 lb
Anchura de la pista de barrido	620 mm / 24 in
Anchura del cepillo principal	400 mm / 16 in
Diámetro del cepillo lateral	300 mm / 12 in
Capacidad de la caja colectorora	37 L / 9.8 Gal
Capacidad de la batería 12V,	12 V, 50 Ah
Consumo total de energía	12 VDC, 230 W, 12.6 A
Cargador de baterías	100-240VAC 8A
Productividad media (neta)	1290 m ² /hr / 13850 ft ² /hr
Inclinación máxima	2%
Vibraciones de la máquina en brazos y manos*	<2.5m/s ²
Incertidumbre de la vibración K *	0.8 m/s ²
Nivel de presión acústica L _{PA} *	62 dBA
Incertidumbre acústica K _{PA} *	3 dBA
Nivel de potencia acústica L _{WA} + Incertidumbre K _{WA} *	81 dB(A)
Índice de protección	IPX3
temperatura de operación	min. -15°C, max. 40°C

* Valores determinados según EN 60335-2-72

Tennant Company
PO Box 1452, Minneapolis, MN 55440 USA
Teléfono: 001-800-553-8033 o 001-763- 513-2850
www.nobles.com

Instrucciones originales. Copyright © 2012 TENNANT Company. Todos los derechos reservados. Impreso en Alemania. Las características técnicas y las piezas están sujetas a modificaciones sin previo aviso.

Datos de la máquina

Rellene esta ficha cuando realice la instalación, para utilizarla como referencia en el futuro.

Número de modelo - _____

Número de serie - _____

Fecha de instalación - _____

MEDIDAS DE SEGURIDAD (GUARDE ESTAS INSTRUCCIONES)



Este símbolo advierte al operario de los riesgos y hábitos peligrosos que podrían causar lesiones corporales graves o mortales.



ADVERTENCIA: para reducir el riesgo de incendios, explosiones, descargas eléctricas o lesiones:

- No utilice la máquina cerca de líquidos, polvos o vapores inflamables.

Esta máquina no está equipada con motores a prueba de explosiones. Los motores eléctricos producirán chispas tanto durante el arranque como durante su utilización que pueden provocar incendios o explosiones si utiliza la máquina en presencia de líquidos o vapores inflamables o partículas combustibles.

- No recoja materiales tóxicos o inflamables ni residuos humeantes o ardiendo.
- Las baterías emiten hidrógeno. Mantenga brasas o fuego alejados cuando cargue las baterías.
- Cargue siempre las baterías en un lugar bien ventilado.
- Desconecte los cables de batería y el enchufe del cargador antes de realizar operaciones de mantenimiento en la máquina.
- No cargue las baterías si el cable está dañado. No modifique el enchufe.
- No utilice la máquina sobre superficies mojadas. Guárdela en un lugar cerrado.

Las siguientes medidas de seguridad hacen referencia a situaciones potencialmente peligrosas para el operario o el equipo.

SEGURIDAD:

1. No utilice la máquina:

- A no ser que cuente con la formación y autorización adecuada.
- A no ser que haya leído y comprendido el manual del operario.
- A no ser que tenga la capacidad física y mental para seguir las instrucciones de la máquina.
- En lugares demasiado oscuros para ver los controles o utilizar la máquina con seguridad.
- Si la máquina no funciona correctamente.
- Sin haber colocado los filtros y/o la caja recolectora.

2. Antes de utilizar la máquina:

- Asegúrese de que todos los dispositivos de seguridad están bien instalados y funcionan correctamente.

3. Al utilizar la máquina:

- Utilice la máquina solamente como se describe en el manual.
- No recoja objetos como cuerdas, hilos o cables que pudieran enredar el cepillo.
- Informe inmediatamente de las averías de la máquina o de si el funcionamiento no es correcto.
- Vigile la máquina en todo momento y no la deje en una superficie inestable.
- No permita que los niños jueguen encima o alrededor de la máquina.
- Mantenga a los niños y a las personas no autorizadas alejados de la máquina mientras esté en uso.

- Vaya despacio en superficies resbaladizas.
- No utilice la máquina en superficies inclinadas que excedan el 2%.
- No utilice la máquina para transportar personas u objetos.
- En ambientes con mucho polvo, protéjase con una mascarilla contra el polvo, gafas y guantes.
- Cepillo giratorio. Mantenga alejadas las manos
- Sea precavido cuando levante la caja colectora llena para evitar dolores de espalda.
- Protéjase con guantes cuando retire objetos punzantes del filtro.
- Apague la máquina si no está funcionando correctamente o si el cepillo se bloquea.

4. Antes de dejar la máquina o realizar operaciones de mantenimiento:

- Detenga la máquina en una superficie plana.
- Sitúe el interruptor principal en la posición de apagado.

5. Cuando realice operaciones de mantenimiento:

- Sitúe el interruptor principal en la posición de apagado.
- Desconecte el cable de la batería y el del cargador antes realizar las operaciones de mantenimiento.
- Utilice guantes y gafas de protección al trabajar con las baterías o sus cables.
- Evite el contacto con el ácido de las baterías.
- Utilice repuestos suministrados o aprobados por el fabricante.
- Todas las reparaciones debe realizarlas personal técnico cualificado.
- Evite las partes en movimiento. No lleve prendas sueltas ni joyas y recójase el pelo si lo tiene largo.
- No moje la máquina rociándola o utilizando una manguera cuando esté cerca de componentes eléctricos.
- No modifique el diseño original de la máquina.
- Todos los trabajos deben realizarse con visibilidad suficiente e iluminación adecuada.
- Protéjase llevando las prendas o equipo adecuados.

6. Al transportar la máquina:

- Sitúe el interruptor principal en la posición de apagado.
- Pida ayuda para levantar la máquina.
- Utilice una rampa de carga capaz de soportar el peso de la máquina.
- No baje ni suba escaleras utilizando las ruedas de la máquina.
- Utilice las correas de sujeción para fijar la máquina cuando la transporte en un vehículo.

Información sobre el cargador de batería integrado

El tipo de carga que realiza el cargador de batería integrado está específicamente configurado para cargar una batería sellada GEL de 12V. Cuando se cambia la batería, es importante utilizar el mismo tipo de batería. En caso contrario la batería o el cargador podrían resultar dañados.

Para las instrucciones de uso del cargador, consulte el manual del cargador de batería que se incluye con la máquina.

Adhesivo de seguridad

El adhesivo de seguridad se encuentra en la posición indicada a continuación. Sustituya el adhesivo si se ha perdido, está deteriorado o es ilegible.

⚠ WARNING	
TO REDUCE THE RISK OF FIRE, ELECTRIC SHOCK, OR INJURY: <ul style="list-style-type: none"> • Do Not Use Near Flammable Liquids, Vapors or Combustible Dusts. • Do Not Pick Up Flammable or Toxic Materials and Burning Debris. • Keep Sparks and Open Flame Away When Charging Batteries. • Disconnect Battery Cables and Charger Cord Before Servicing. • Do Not Charge Batteries With Damaged Cord. Do Not Modify Plug. • Do Not Use On Wet Surfaces. Store Indoors. 	
⚠ AVERTISSEMENT	
POUR RÉDUIRE LES RISQUES D'INCENDIE, DE CHOC ÉLECTRIQUE OU DE BLESSURE: <ul style="list-style-type: none"> • N'utilisez Pas Près de Liquides, Vapeurs ou Poussières Inflammables. • Ne Ramassez Pas de Matériaux Inflammables ou Toxiques et de Déchets Enflammés. • Éloignez les Sources d'Étincelles ou de Flamme Ouverte Lors du Chargement des Batteries. • Débranchez les Câbles de Batterie et la Cordon du Chargeur Avant l'Entretien. • Ne Chargez Pas la Batterie Avec un Cordon Endommagé. Ne Modifiez Pas la Prise. • N'utilisez Pas Sur des Surfaces Humides. Entreposez à l'Intérieur. 	
⚠ ADVERTENCIA	
PARE REDUCIR EL RIESGO DE INCENDIO, CHOQUE ELÉCTRICO, O LESIONES: <ul style="list-style-type: none"> • No Use Cerca De Líquidos Flamables, Vapores Ó Materiales Combustibles. • No Recoja Materiales Flamables Ó Tóxicos Ni Desechos Candescentes. • Mantenga Chispas Y Fuego Alejados Mientras Carga Baterías. • Desconecte Cable De Batería Y Cable Del Cargador Antes Del Mantenimiento. • No Cargue Baterías Con Cable Dañado. No Altere El Enchufe. • No Lo Utilice En Superficies Húmedas. Guarde Bajo Techo. 	
1071275	



Introduction

Ce manuel accompagne chaque nouveau modèle. Il fournit les instructions nécessaires au fonctionnement et à l'entretien, ainsi que les informations relatives au remplacement des pièces.



Lisez toutes les instructions avant d'utiliser cette machine.

Utilisation prévue

Cette balayeuse autotractée alimentée par batterie est destinée à un usage commercial (par exemple, dans les bâtiments, entrepôts, parcs de stationnement et trottoirs. Elle peut être utilisée à l'intérieur et à l'extérieur, et permet de ramasser la poussière sèche et non-inflammable, ainsi que les déchets sur sol dur et sec et les surfaces des moquettes. Elle ne peut pas être utilisée sur des surfaces humides ou pour le ramassage de matériaux inflammables ou toxiques.

Informations générales

Cette machine fournit d'excellents services. Toutefois, vous obtiendrez les meilleurs résultats, à moindre coût, si :

- La machine doit être manipulée avec précaution.
- La machine fait l'objet d'un entretien régulier, conformément aux instructions d'entretien fournies.
- L'entretien de la machine s'effectue avec les pièces fournies par le fabricant ou des pièces équivalentes.



Protection de l'environnement

Pour éliminer les matériaux d'emballage et les composants usagés de la machine en respectant l'environnement, respectez les réglementations locales en vigueur concernant la mise au rebut des déchets.



Pensez toujours à recycler.

Caractéristiques techniques

Modèle	Scout 5
Longueur	923 mm / 37 in
Largeur	650 mm / 25 in
Hauteur	557 mm / 22 in
Poids	55 kg / 121 lb
Largeur de la trace de balayage	620 mm / 24 in
Largeur de la brosse principale	400 mm / 16 in
Diamètre de la brosse latérale	300 mm / 12 in
Capacité du bac à déchets	37 L / 9.8 Gal
Capacité de la batterie 12 V,	12 V, 50 Ah
Consommation électrique totale	12 VDC, 230 W, 12.6 A
Chargeur de la batterie	100-240VAC 8A
Taux de rendement (net)	1290 m ² /hr / 13850 ft ² /hr
Pente maximum	2%
Vibrations de la machine au niveau du système main-bras *	<2.5m/s ²
Incertitude de vibrations de la machine K *	0.8 m/s ²
Niveau de pression acoustique L _{PA} *	62 dBA
Incertitude acoustique K _{PA} *	3 dBA
Niveau de puissance acoustique L _{WA} + incertitude K _{WA} *	81 dB(A)
Degré de protection	IPX3
température de fonctionnement	min. -15°C, max. 40°C

* Valeurs déterminées conformément à la norme EN 60335-2-72

Tennant Company
PO Box 1452, Minneapolis, MN 55440 États-Unis d'Amérique
Téléphone : (800) 553-8033 ou (763) 513-2850
www.nobles.com
Instructions d'origine. Copyright © 2012 TENNANT Company.
Tous droits réservés. Imprimé en Allemagne.
Les caractéristiques et les pièces sont susceptibles d'être modifiées sans avis préalable.

Données de la machine

À remplir au moment de l'installation pour s'y référer ultérieurement.

N° de modèle - _____

N° de série - _____

Date d'installation - _____

CONSIGNES DE SÉCURITÉ IMPORTANTES (CONSERVEZ CES INSTRUCTIONS)



Ce symbole avertit l'opérateur de situations à risque ou de pratiques dangereuses pouvant provoquer des blessures graves, voire mortelles.



AVERTISSEMENT : Afin de réduire le risque d'incendie, d'explosion, de choc électrique ou de blessure :

- N'utilisez pas la machine à proximité de liquides ou de vapeurs inflammable, ni de poussières combustibles.

La machine n'est pas équipée de moteurs protégés contre les explosions. Les moteurs électriques génèrent des étincelles au moment du démarrage et pendant leur fonctionnement, ce qui peut entraîner un incendie instantané ou une explosion si la machine est utilisée dans une zone où des vapeurs/liquides inflammables ou des poussières combustibles sont présents.

- Ne ramassez pas de matériaux inflammables ou toxiques, ni de déchets incandescents.
- Les batteries émettent du gaz hydrogène. Éloignez les sources d'étincelles ou de flammes ouvertes lors du chargement des batteries.
- Rechargez les batteries dans un endroit bien aéré.
- Débranchez les câbles de la batterie et le cordon du chargeur avant l'entretien.
- Ne chargez pas la batterie avec un cordon endommagé. Ne modifiez pas la prise.
- N'utilisez pas la machine sur des surfaces humides. Entreposez la machine à l'intérieur.

Les consignes de sécurité mentionnées ci-après indiquent les situations présentant un danger pour l'opérateur ou l'équipement.

POUR VOTRE SÉCURITÉ :

1. N'utilisez pas la machine :
 - Si vous n'y êtes pas formé et autorisé.
 - Avant d'avoir lu et compris le manuel d'utilisation.
 - Si nous n'êtes pas mentalement et physiquement capable de suivre les instructions d'utilisation de la machine.
 - Dans les endroits trop sombres pour pouvoir distinguer les commandes de la machine ou l'utiliser en toute sécurité.
 - Si elle n'est pas en bon état de marche.
 - Sans bac à déchets et/ou filtre en place.
2. Avant de mettre la machine en marche :
 - Assurez-vous que tous les dispositifs de sécurité sont en place et fonctionnent correctement.
3. Lors de l'utilisation de la machine :
 - Utilisez la machine uniquement tel qu'indiqué dans ce manuel.
 - Ne ramassez pas d'objets susceptibles de se coincer dans la brosse (tel que des cordes, ficelles ou fils).
 - Signalez immédiatement tout dommage ou dysfonctionnement.
 - Ne laissez jamais la machine sans surveillance ou sur une surface non plane.
 - Empêchez les enfants de jouer à proximité de la machine.

- Maintenez les enfants et les personnes non autorisées à l'écart de la machine pendant son utilisation.
 - Roulez lentement sur les surfaces glissantes.
 - N'utilisez pas la machine sur des pentes dépassant 2 %.
 - N'utilisez pas la machine pour transporter des personnes ou des objets.
 - Portez un masque antipoussière, des lunettes protectrices et des gants dans les environnements poussiéreux.
 - Brosse en rotation. Éloignez vos mains.
 - Lors du levage des bacs à déchets pleins, faites attention à ne pas vous faire un tour de reins.
 - Portez des gants renforcés pour ramasser les objets tranchants des bacs à déchets.
 - Mettez la machine hors tension si la brosse se coince ou la machine ne fonctionne pas correctement.
4. Avant de quitter la machine ou d'en effectuer l'entretien :
- Arrêtez-la sur une surface plane.
 - Placez le commutateur principal en position OFF.
5. Lors de l'entretien de la machine :
- Placez le commutateur principal en position OFF.
 - Débranchez le câble de la batterie et la prise du chargeur avant de travailler sur la machine.
 - Portez des gants et des lunettes de protection lorsque vous manipulez les batteries ou les câbles de batterie.
 - Évitez tout contact avec l'acide des batteries.
 - Utilisez des pièces de rechanges fournies ou approuvées par le fabricant.
 - Toutes les réparations doivent être effectuées uniquement par un technicien qualifié.
 - Évitez les pièces mobiles. Ne portez pas de vêtements amples et attachez vos cheveux s'ils sont longs.
 - N'utilisez pas de jet ou de tuyau de pression à proximité des composants électriques de la machine.
 - Ne modifiez pas la conception d'origine de la machine.
 - Tous les travaux doivent être exécutés avec une visibilité suffisante et/ou un éclairage approprié.
 - Portez un équipement de protection approprié.
6. Lors du transport de la machine :
- Placez le commutateur principal en position OFF.
 - Demandez de l'aide pour soulever la machine.
 - Utilisez une rampe de chargement capable de supporter le poids de la machine.
 - Ne faites pas rouler la machine dans les escaliers.
 - En cas de transport par véhicule, arrimez la machine avec des sangles.

Informations concernant le chargeur de batterie embarqué

Le profil du chargeur de batterie embarqué est spécialement conçu pour une batterie GEL scellée de 12 V. Lors de l'installation ou du remplacement d'une batterie, il est important d'utiliser une batterie du même type, sans quoi, la batterie et/ou le chargeur peuvent être endommagés.

Pour les instructions de fonctionnement du chargeur de batterie, reportez-vous au manuel fourni avec la machine.

Étiquette de mise en garde

L'étiquette de mise en garde se trouve sur la machine à l'emplacement indiqué. Remplacez toute étiquette manquante, endommagée ou devenue illisible.

⚠ WARNING	
	
TO REDUCE THE RISK OF FIRE, ELECTRIC SHOCK, OR INJURY: <ul style="list-style-type: none"> • Do Not Use Near Flammable Liquids, Vapors or Combustible Dusts. • Do Not Pick Up Flammable or Toxic Materials and Burning Debris. • Keep Sparks and Open Flame Away When Charging Batteries. • Disconnect Battery Cables and Charger Cord Before Servicing. • Do Not Charge Batteries With Damaged Cord. Do Not Modify Plug. • Do Not Use On Wet Surfaces. Store Indoors. 	
⚠ AVERTISSEMENT	
POUR RÉDUIRE LES RISQUES D'INCENDIE, DE CHOC ÉLECTRIQUE OU DE BLESSURE: <ul style="list-style-type: none"> • N'utilisez Pas Près de Liquides, Vapeurs ou Poussières Inflammables. • Ne Ramassez Pas de Matériaux Inflammables ou Toxiques et de Déchets Enflammés. • Éloignez les Sources d'Étincelles ou de Flamme Ouverte Lors du Chargement des Batteries. • Débranchez les Câbles de Batterie et la Cordon du Chargeur Avant l'Entretien. • Ne Chargez Pas la Batterie Avec un Cordon Endommagé. Ne Modifiez Pas la Prise. • N'utilisez Pas Sur des Surfaces Humides. Entreposez à l'Intérieur. 	
⚠ ADVERTENCIA	
PARE REDUCIR EL RIESGO DE INCENDIO, CHOQUE ELÉCTRICO, O LESIONES: <ul style="list-style-type: none"> • No Use Cerca De Líquidos Flamables, Vapores Ó Materiales Combustibles. • No Recoja Materiales Flamables Ó Tóxicos Ni Desechos Candelentes. • Mantenga Chispas Y Fuego Alejados Mientras Carga Baterías. • Desconecte Cable De Batería Y Cable Del Cargador Antes Del Mantenimiento. • No Cargue Baterías Con Cable Dañado. No Altere El Enchufe. • No Lo Utilice En Superficies Húmedas. Guarde Bajo Techo. 	
1071275	



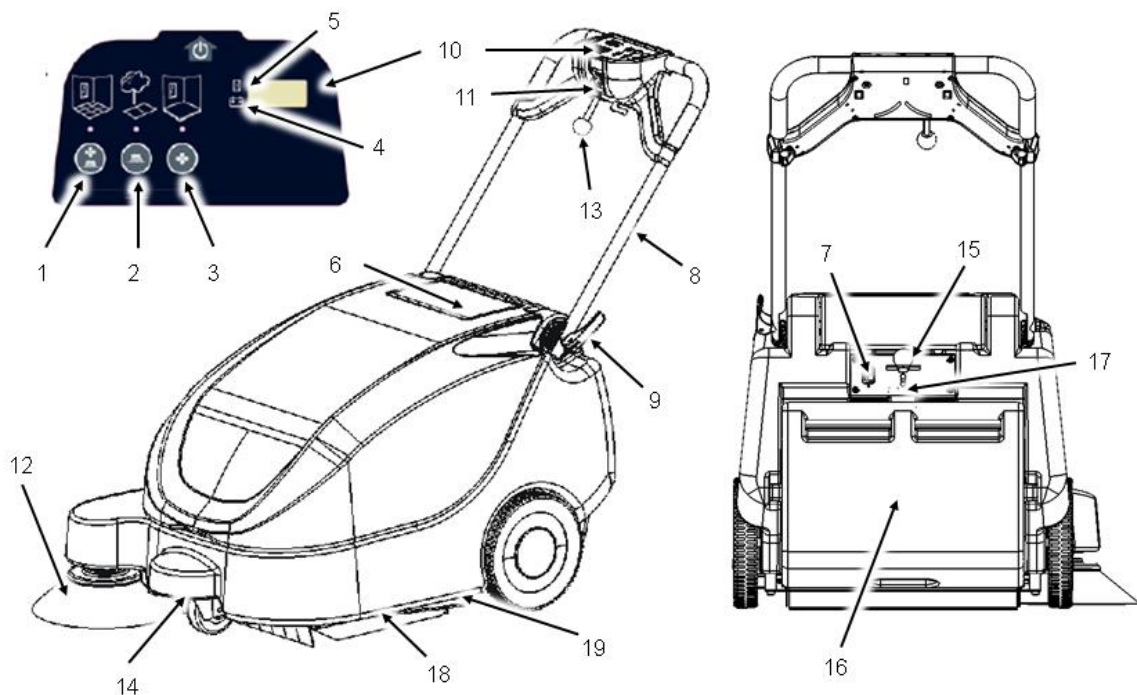

(EN) Machine Components

1. Vacuum, Side Brush, Main Brush Start Button
2. Side Brush, Main Brush Start Button
3. Vacuum, Main Brush Start Button
4. Battery Discharge Indicator
5. Hour Meter
6. Battery Charger Cord Storage Compartment
7. Battery Charger Outlet
8. Adjustable Control Handle
9. Adjustable Control Handle Lever
10. Control Panel
11. Main Power Button
12. Side Brush
13. Side Brush Lever
14. Internal Access Knob
15. Filter Shaker
16. Debris Hopper
17. Debris Hopper Release Lever
18. Dual Main Brushes
19. Anti-static Chain

(FR) Composants de la machine

1. Bouton d'activation de l'aspirateur, de la brosse latérale, de la brosse principale
2. Bouton d'activation de la brosse latérale, de la brosse principale
3. Bouton d'activation de l'aspirateur, de la brosse principale
4. Indicateur du niveau de charge des batteries
5. Compteur horaire
6. Compartiment de stockage du cordon du chargeur de batterie
7. Prise du chargeur de batterie
8. Poignée de commande réglable
9. Levier de poignée de commande réglable
10. Tableau de bord
11. Bouton d'alimentation principale
12. Brosse latérale
13. Levier de la brosse latérale
14. L'accès interne
15. Secoueur de filtre
16. Bac à déchets
17. Levier Bac à déchets
18. Brosses latérales doubles
19. Chaîne antistatique

(ES) Componentes de la máquina

1. Aspirador, cepillo lateral, botón de activación del cepillo principal
2. Cepillo lateral, botón de activación del cepillo principal
3. Aspirador, botón de activación del cepillo principal
4. Indicador de descarga de la batería
5. Contador de horas
6. Compartimento para guardar el cable del cargador de baterías
7. Enchufe del cargador de baterías
8. Manillar de control ajustable
9. Palanca del asa de control ajustable
10. Panel de control
11. Botón de encendido principal
12. Cepillo lateral
13. Palanca del cepillo lateral
14. El acceso interno
15. Sacudidor del filtro
16. Caja colectora
17. Caja colectora palanca
18. Cepillos principales dobles
19. Cadena anti-estática

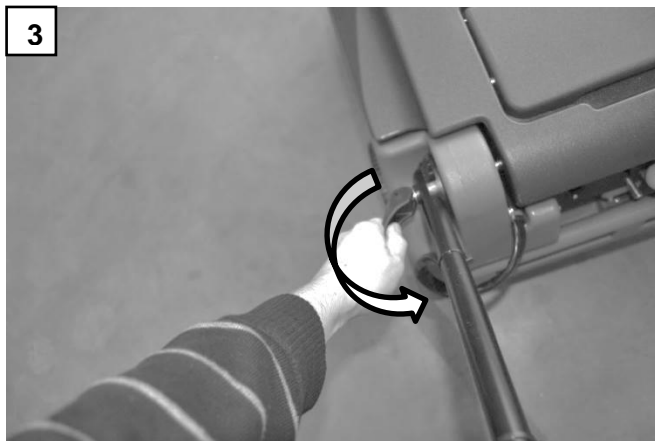
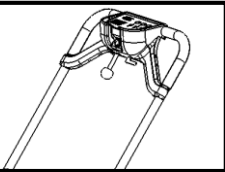
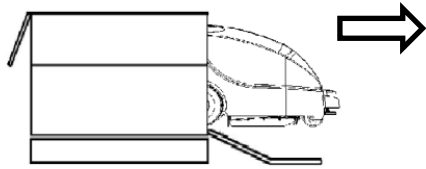
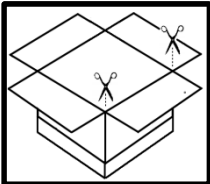

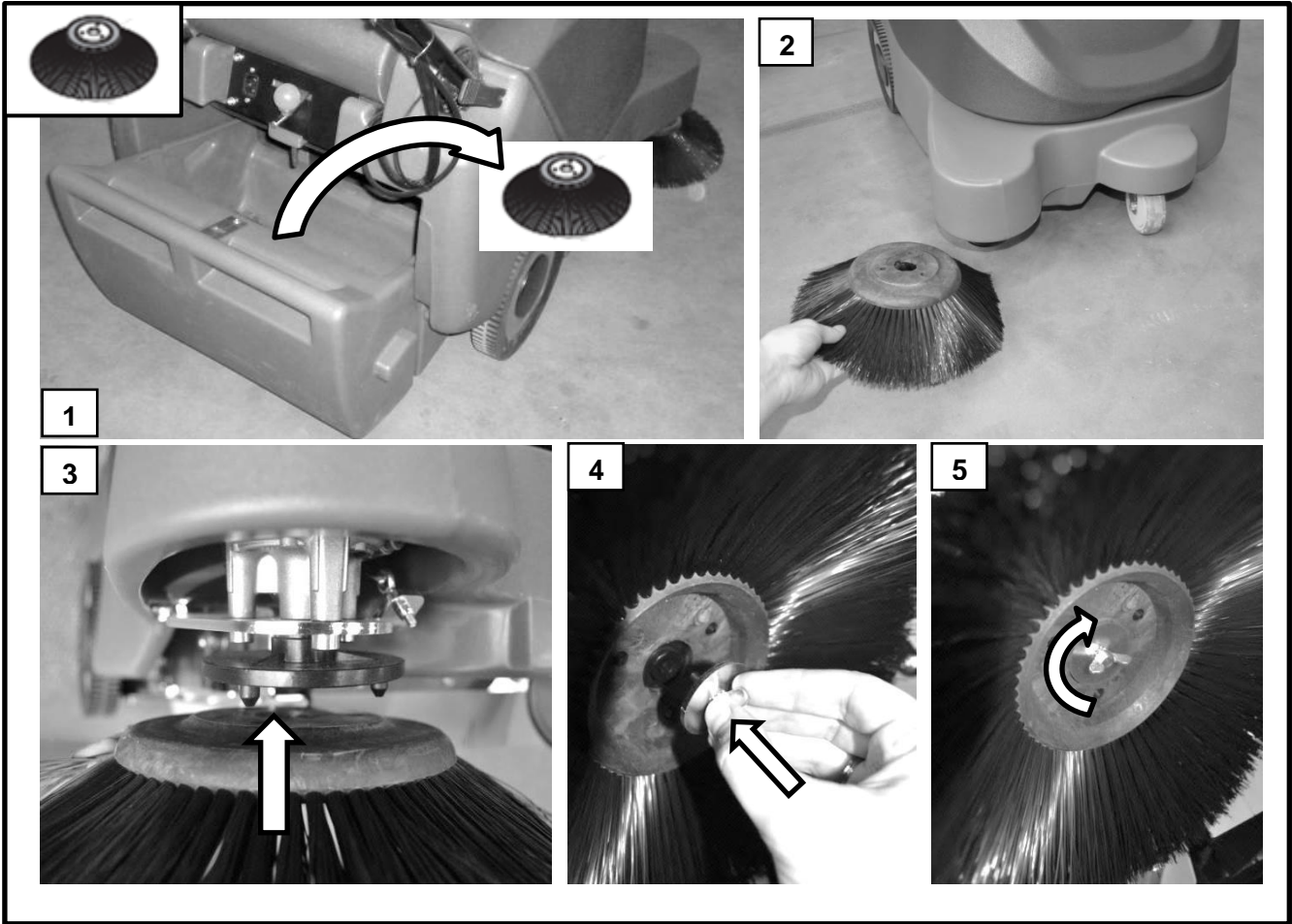

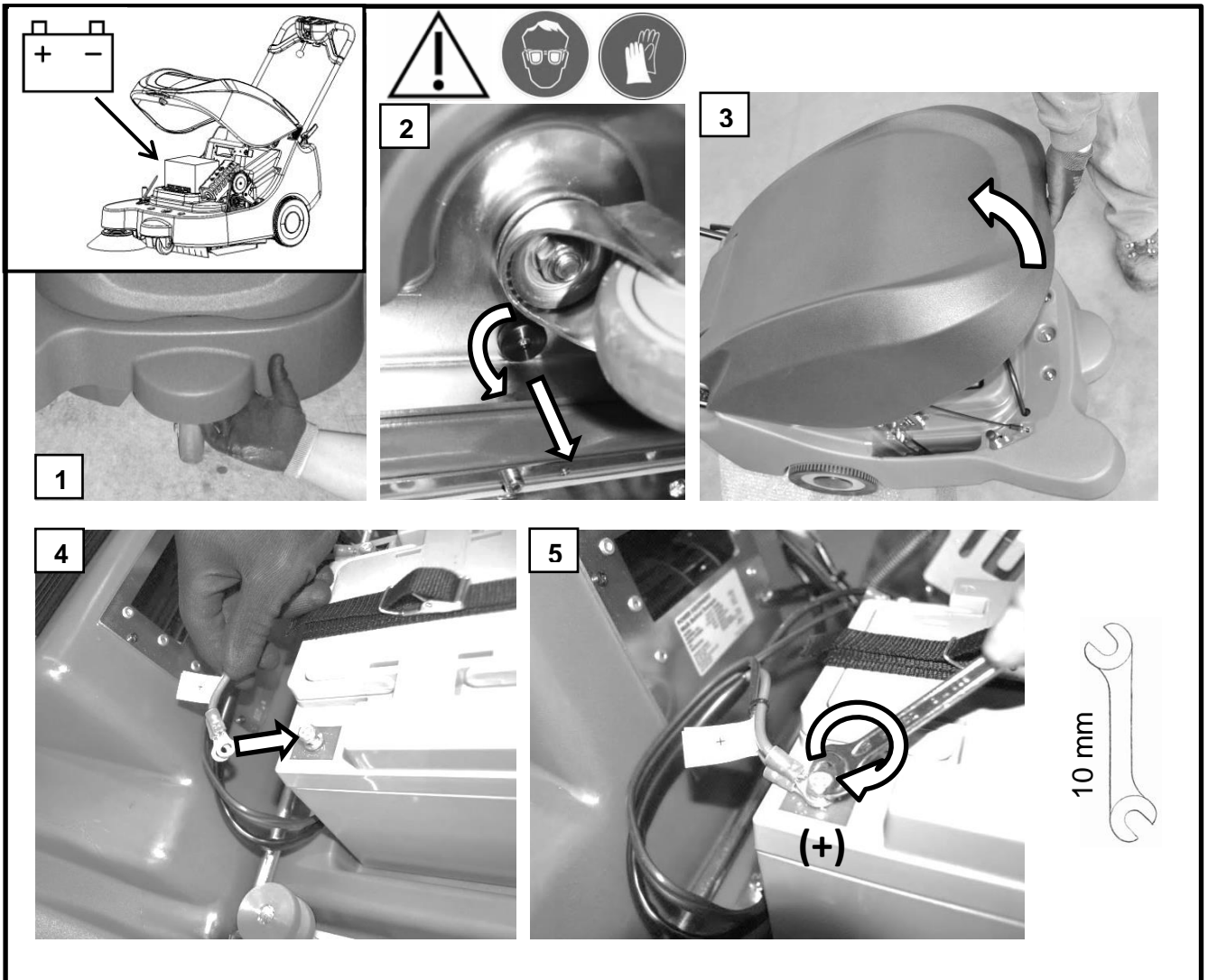

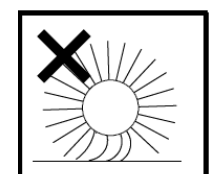
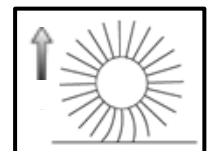
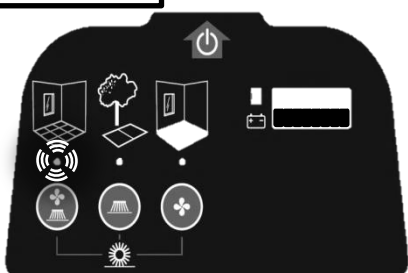
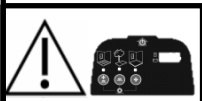
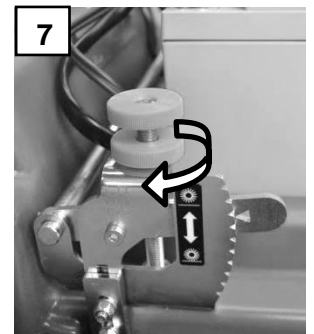
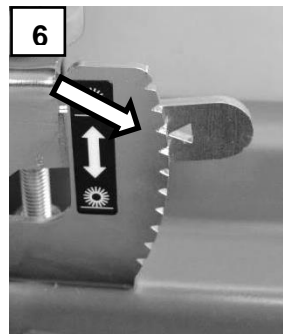
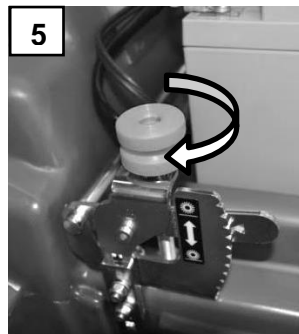
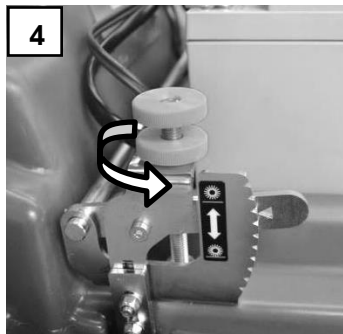
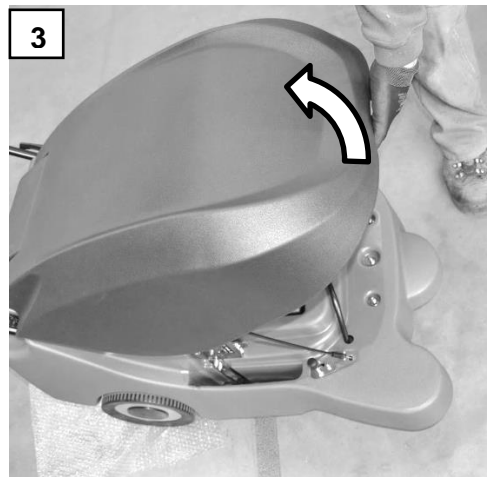
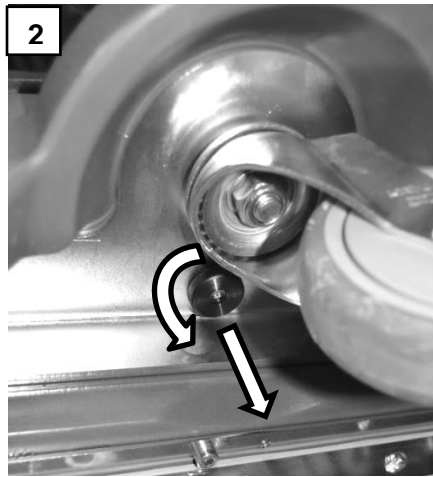
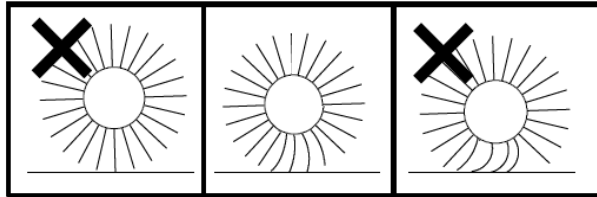
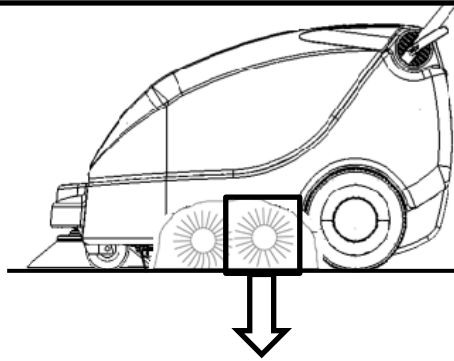
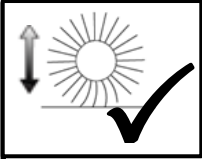

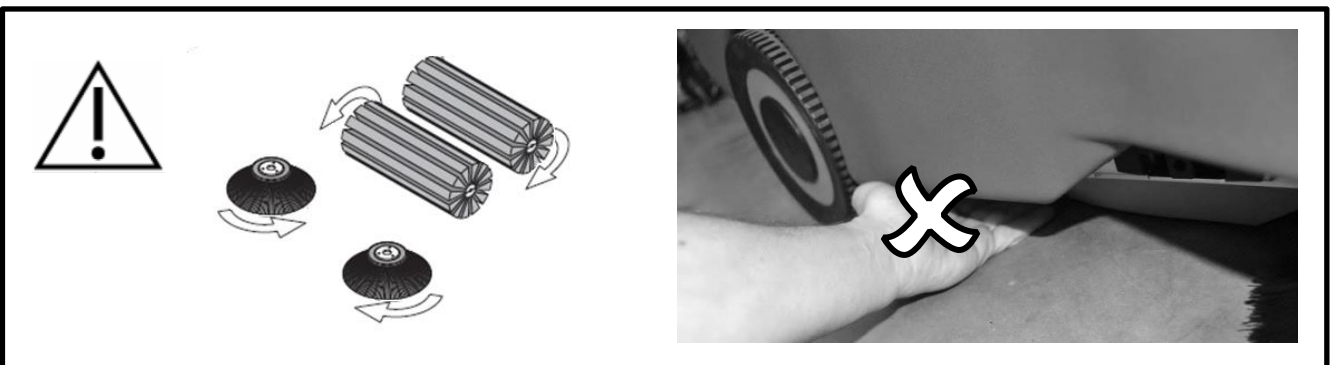
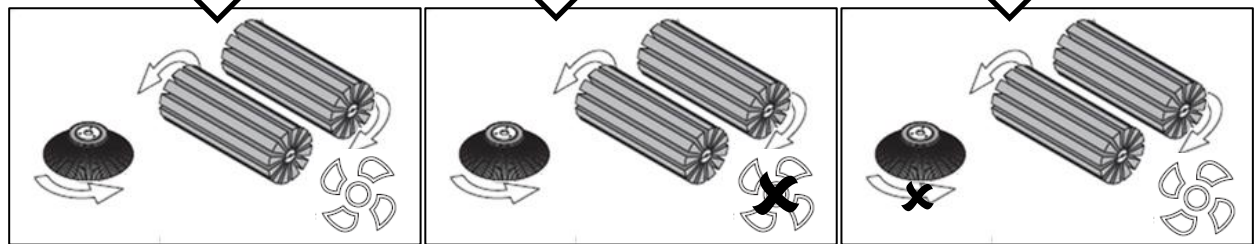
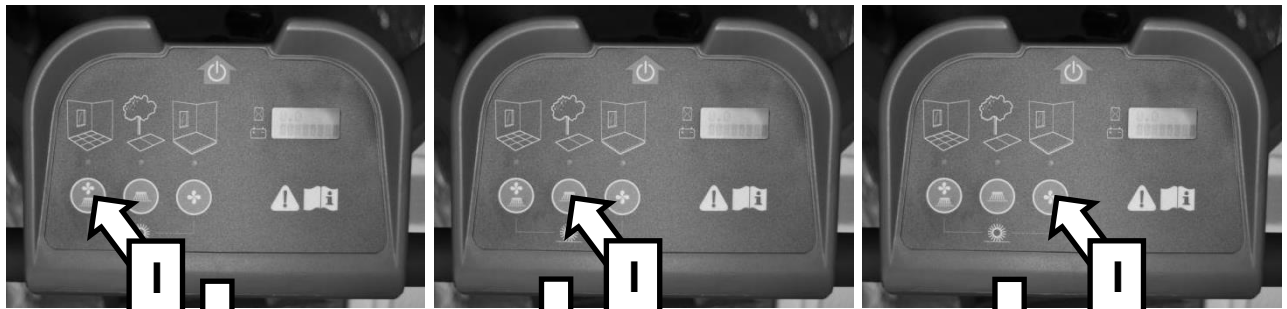
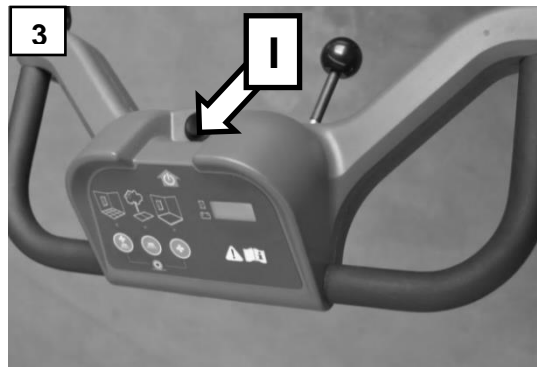
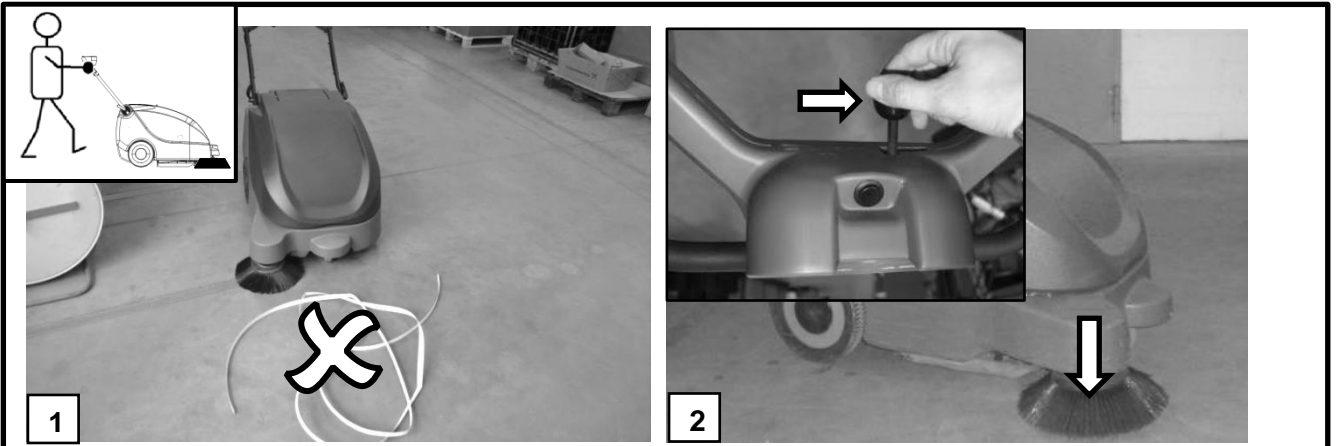

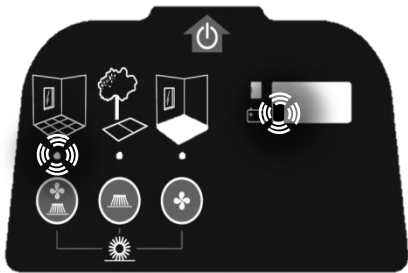
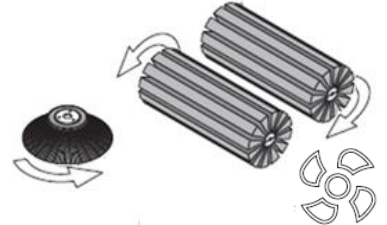
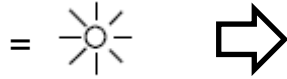
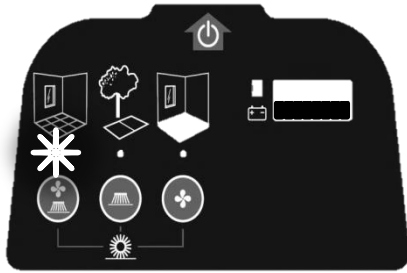
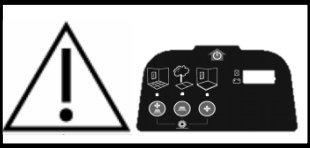

Pg. 15

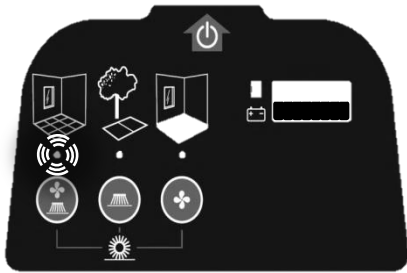
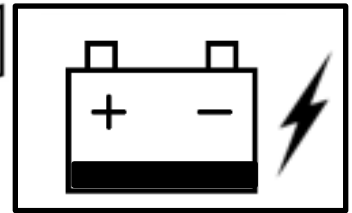

Pg. 16

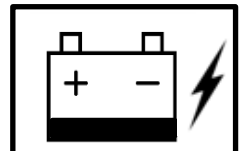
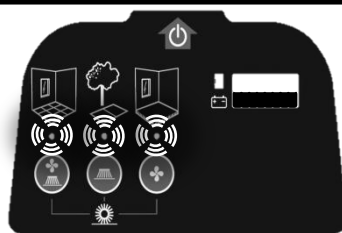
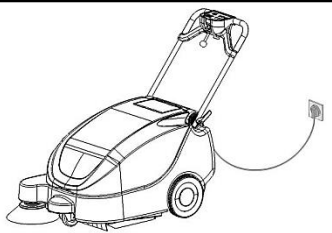
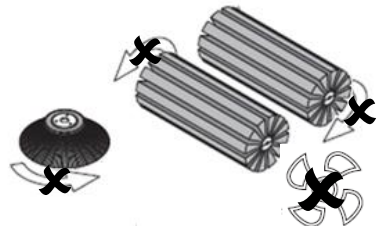
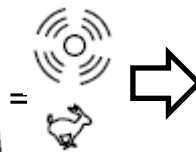
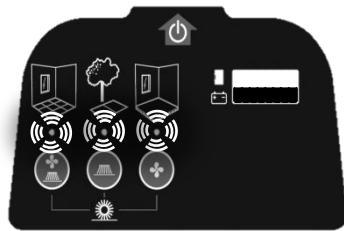
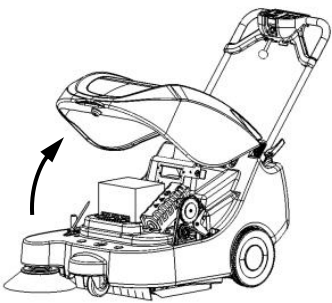
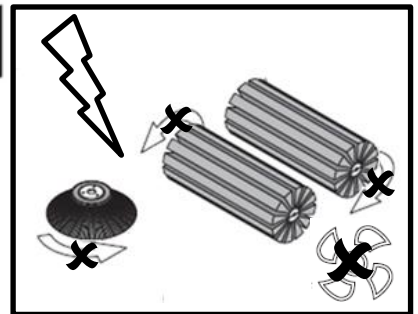

Control Panel LED Code Guide

LED CODE	REASON / FAULT	SOLUTION
One sweeping mode LED is solid	Normal operating condition	No action required
One sweeping mode LED is flashing fast	Motor overload has shut down machine due to obstruction.	Disconnect battery cable and check main brush, side brush and fan. Remove obstruction. Reset circuit breaker button.
One sweeping mode LED is flashing slowly and battery discharge indicator is flashing	Low battery level.	Recharge battery.
All sweeping mode LED's are flashing fast	Machine cover is open. The safety switch has shut down machine.	Close machine cover.
	Machine is in charging mode. Battery charger is plugged into electrical outlet.	No action required or unplug battery charger.
	Defective battery.	Replace battery.
	Machine cover lock-down knob is loose.	Check lock-down knob to ensure knob is tight and machine cover is secure.
	Defective, misaligned or loose machine cover safety switch.	Check, adjust or replace switch.
	Defective motor(s) or loose electrical connection to motor.	Disconnect battery cable and check all motors for proper operation. Reset circuit breaker button.
	Loose or damaged electrical connection.	Disconnect battery cable and check electrical harness for loose or damaged wire connections.
	Main brush and side brush not properly adjusted.	Readjust main and/or brush height. Reset circuit breaker button.
	Motor overload, excessive belt tension.	Check belt tension for proper adjustment, replace belt if worn. Reset circuit breaker button.
	Worn or damaged main brushes.	Replace main brushes.

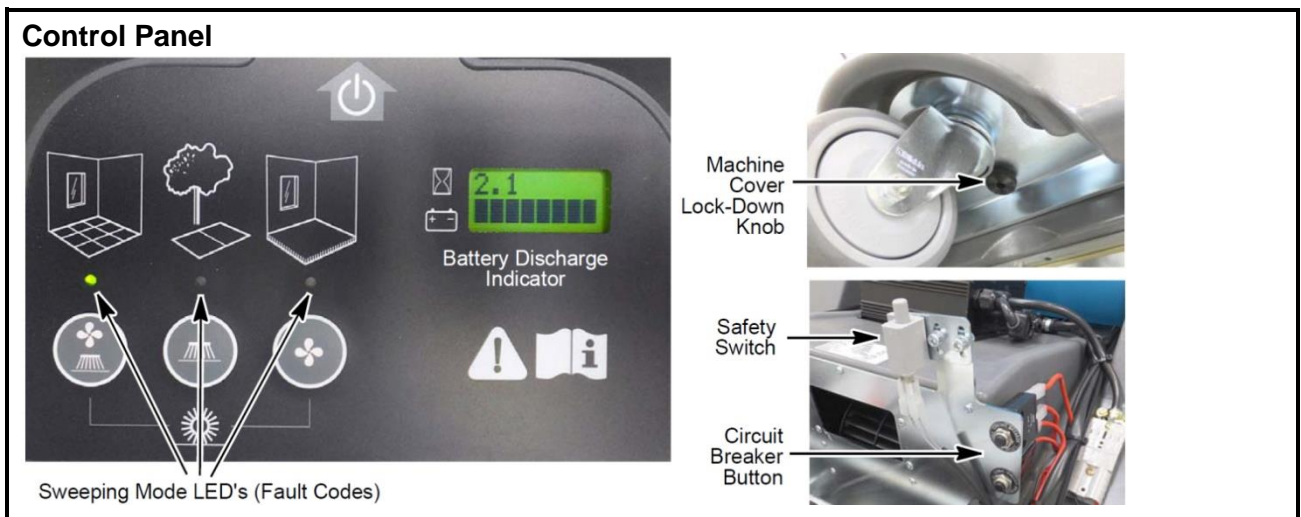

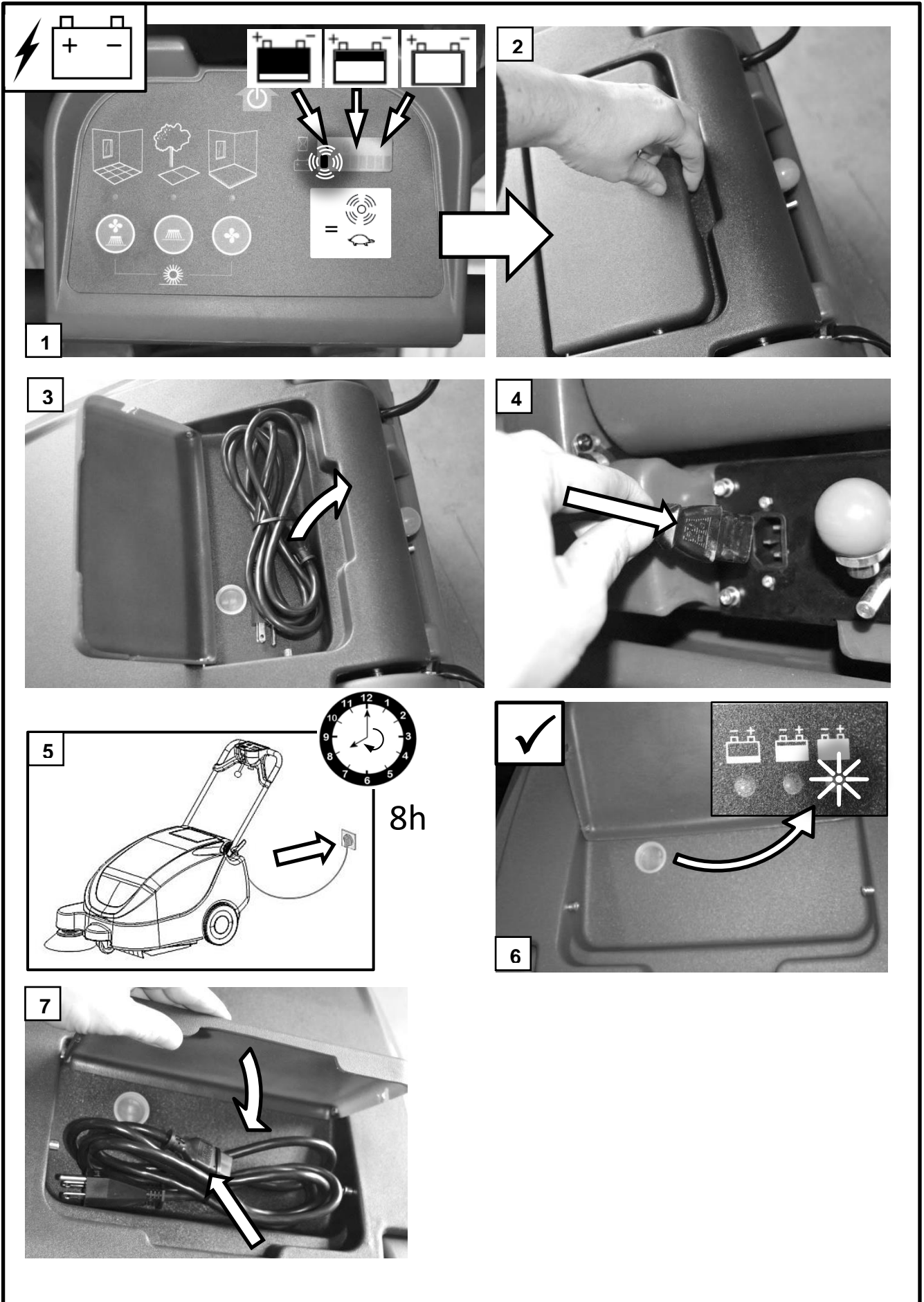

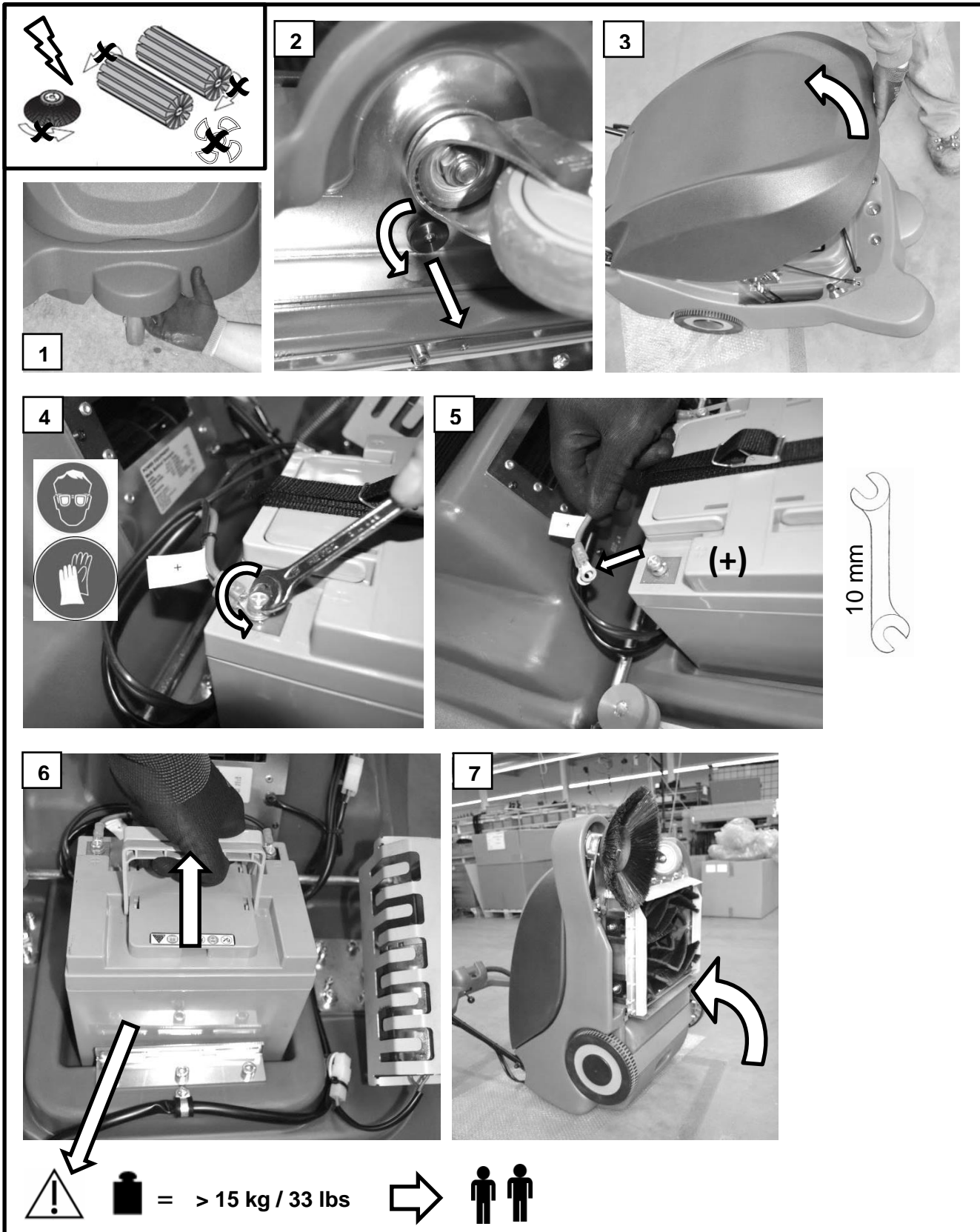

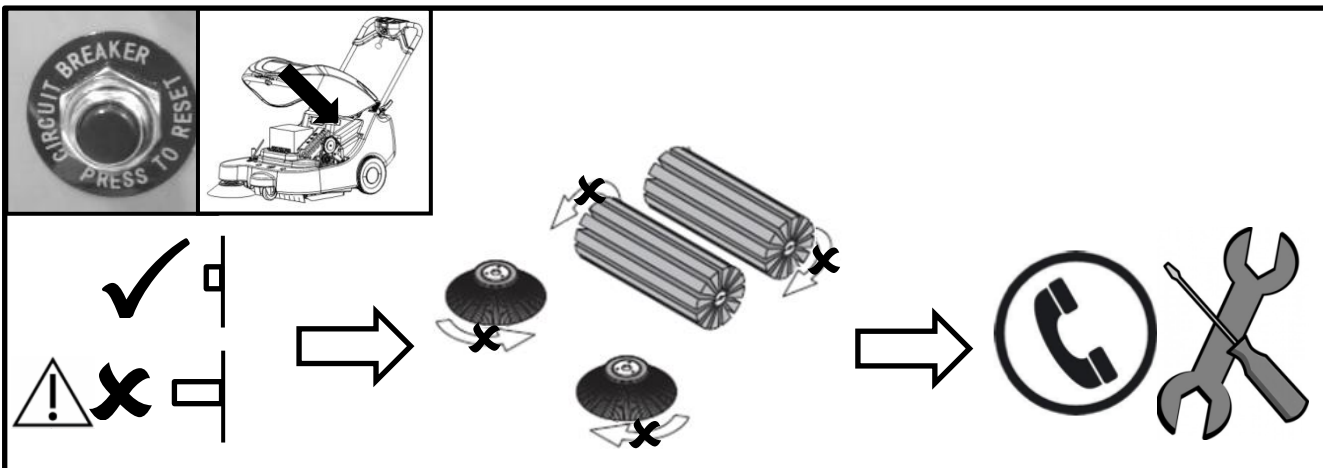
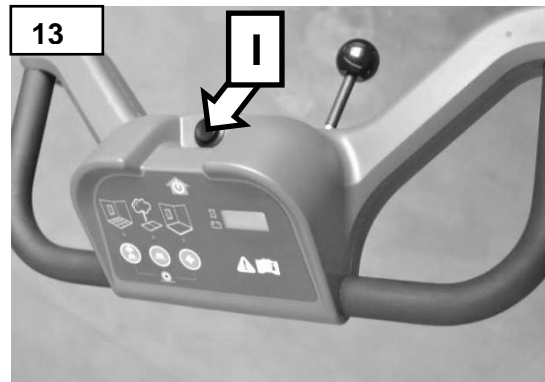
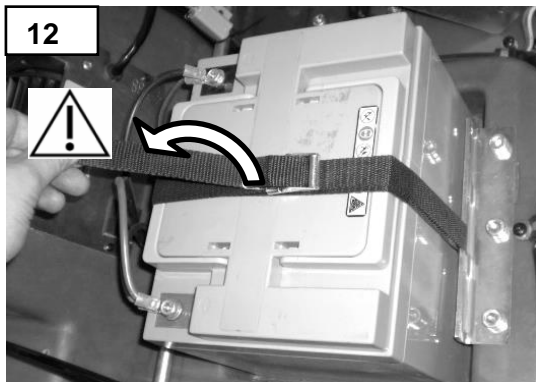
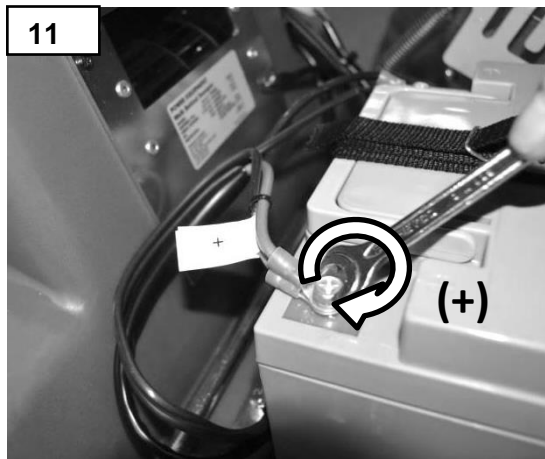
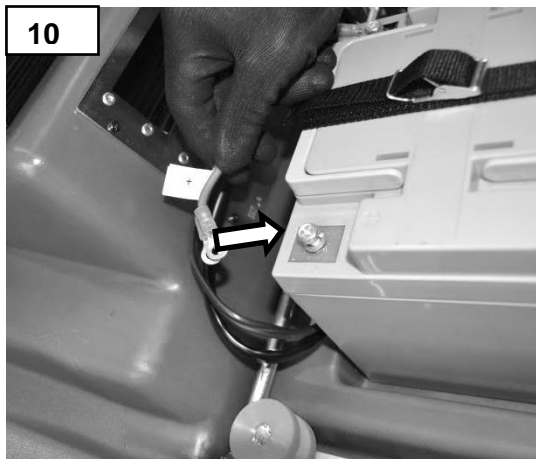
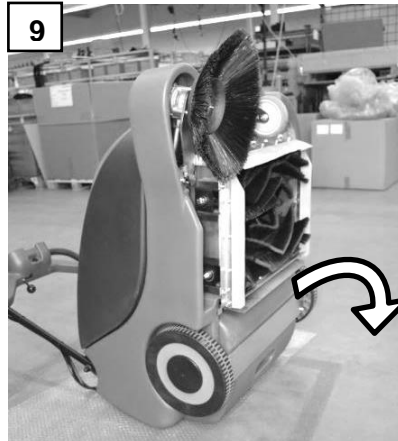

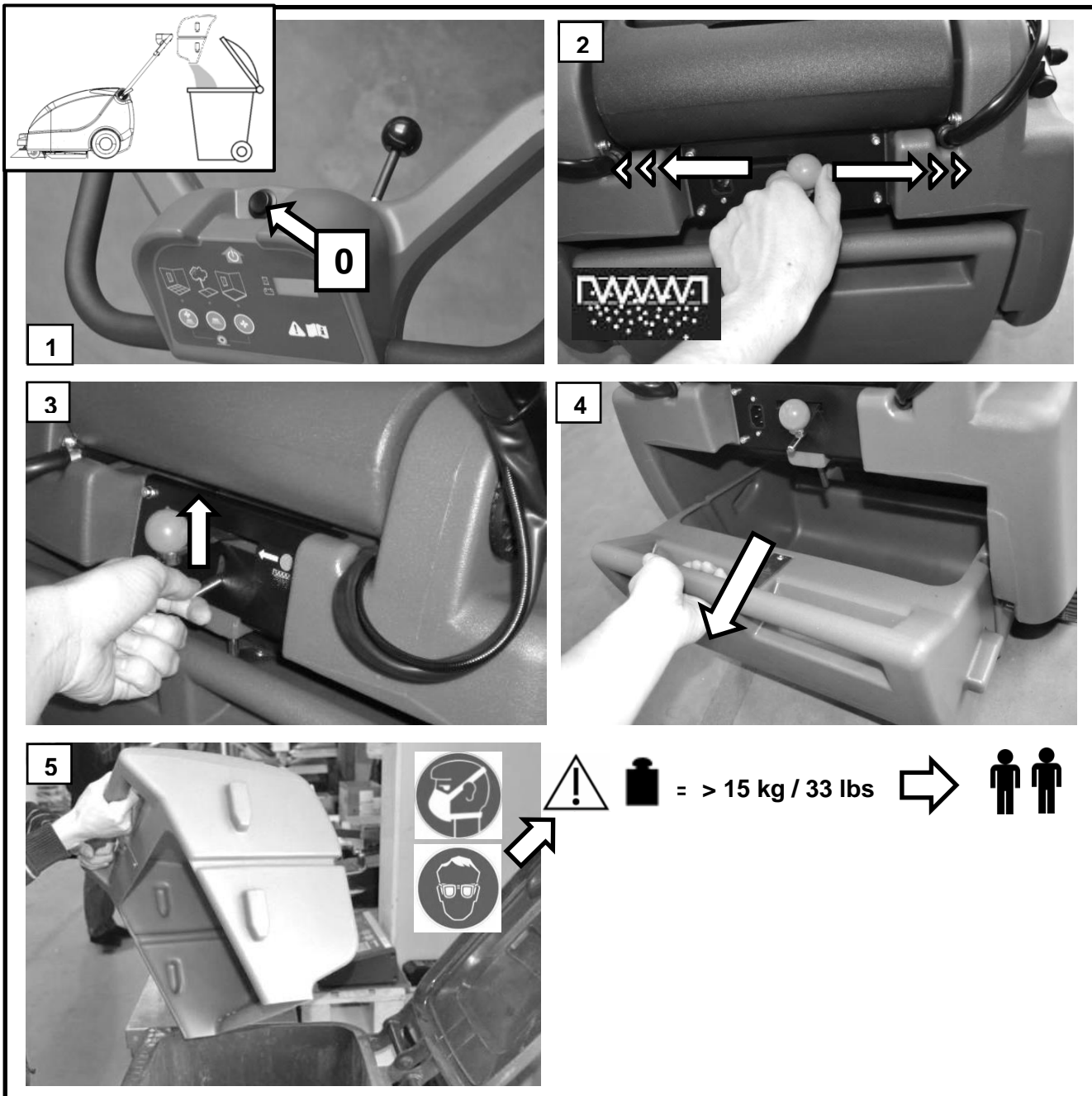

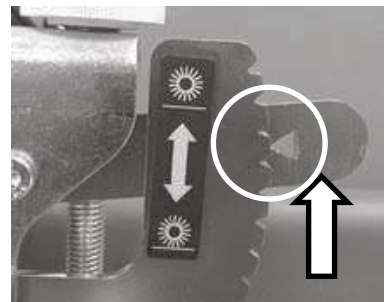
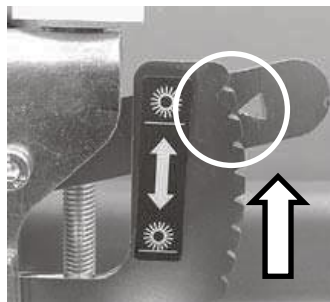
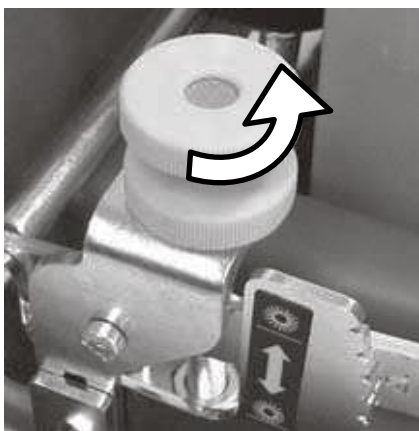
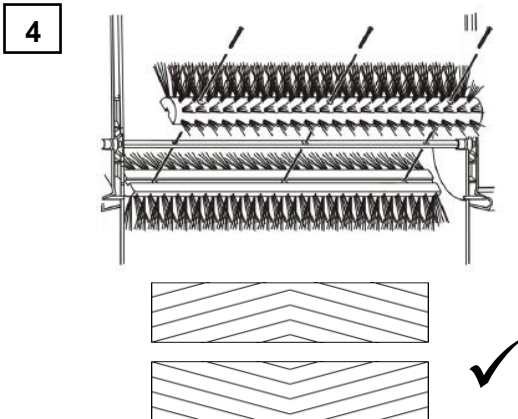
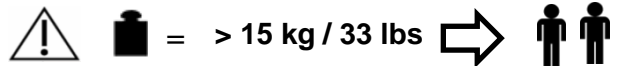
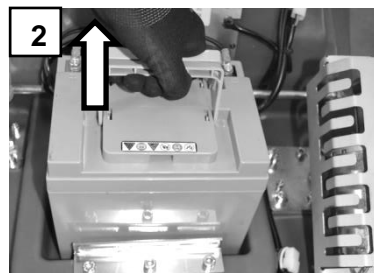
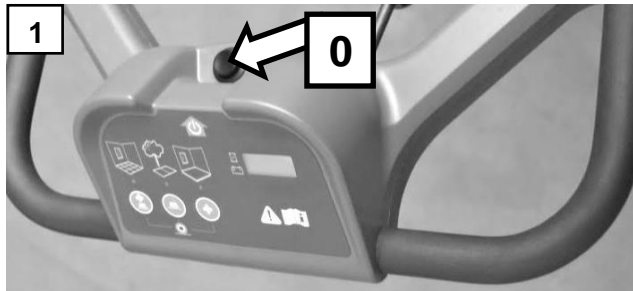
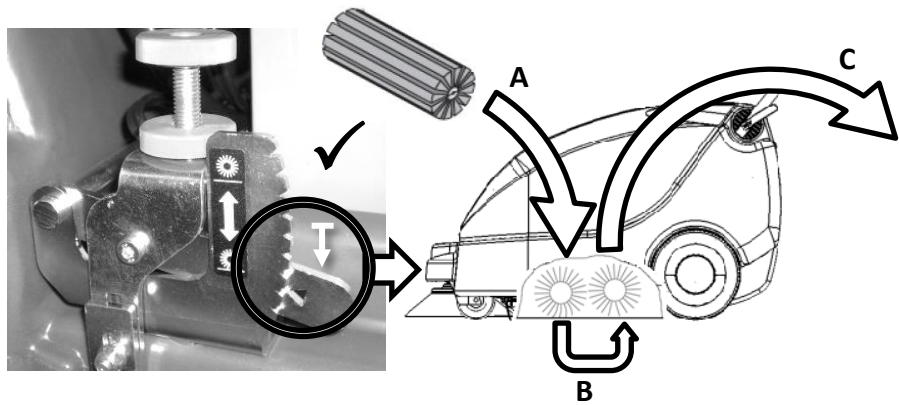
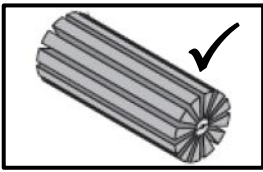

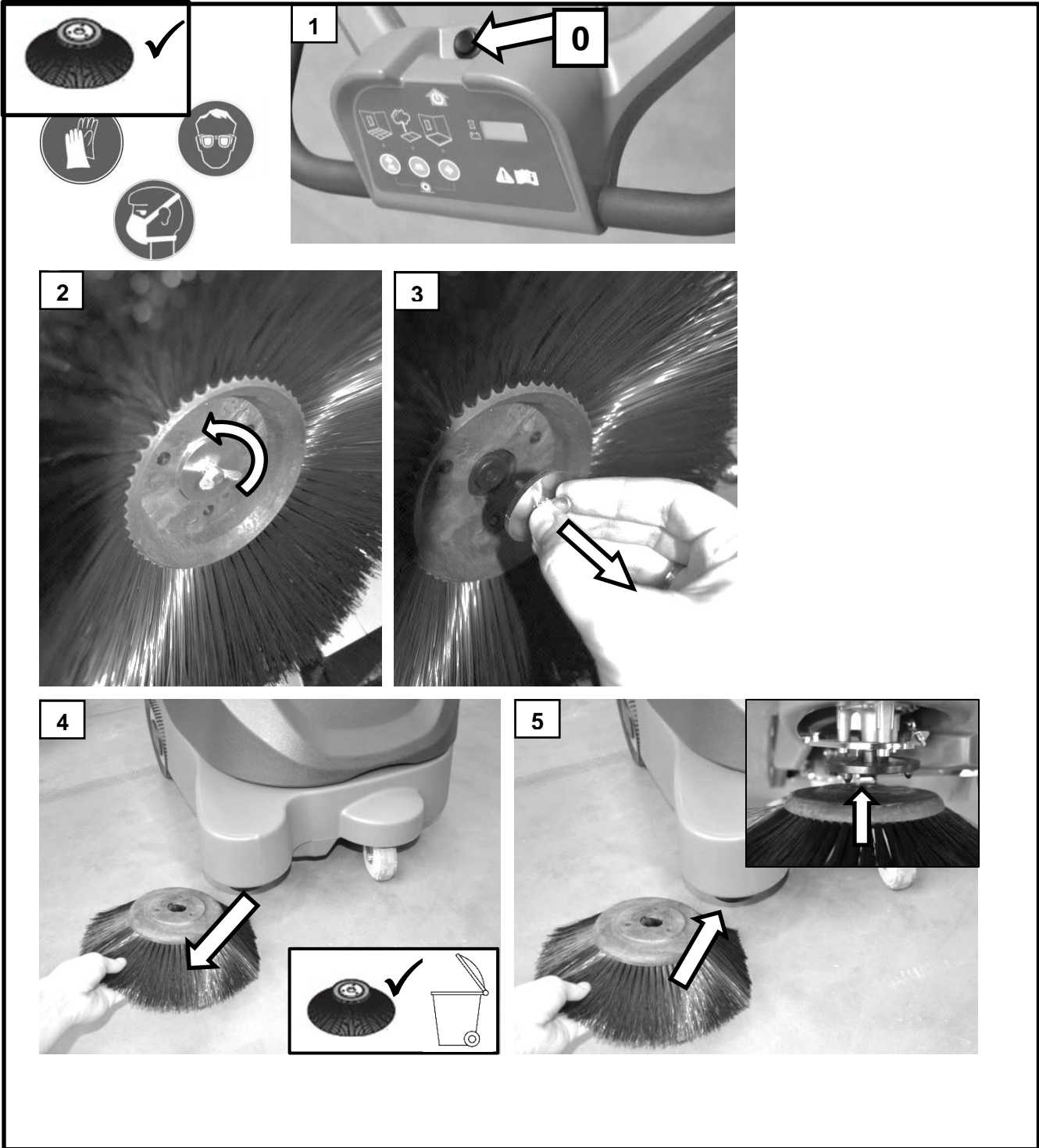

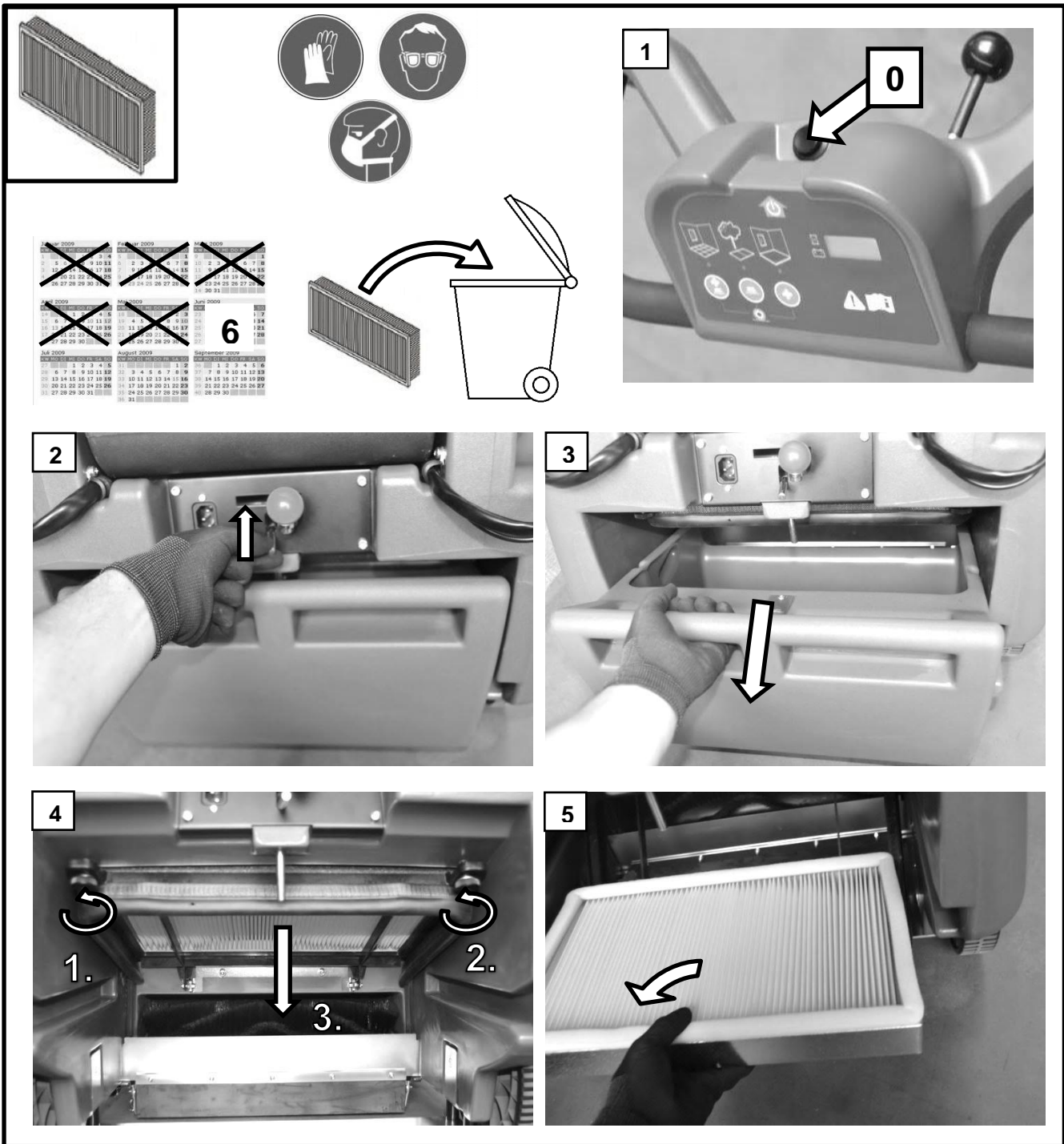

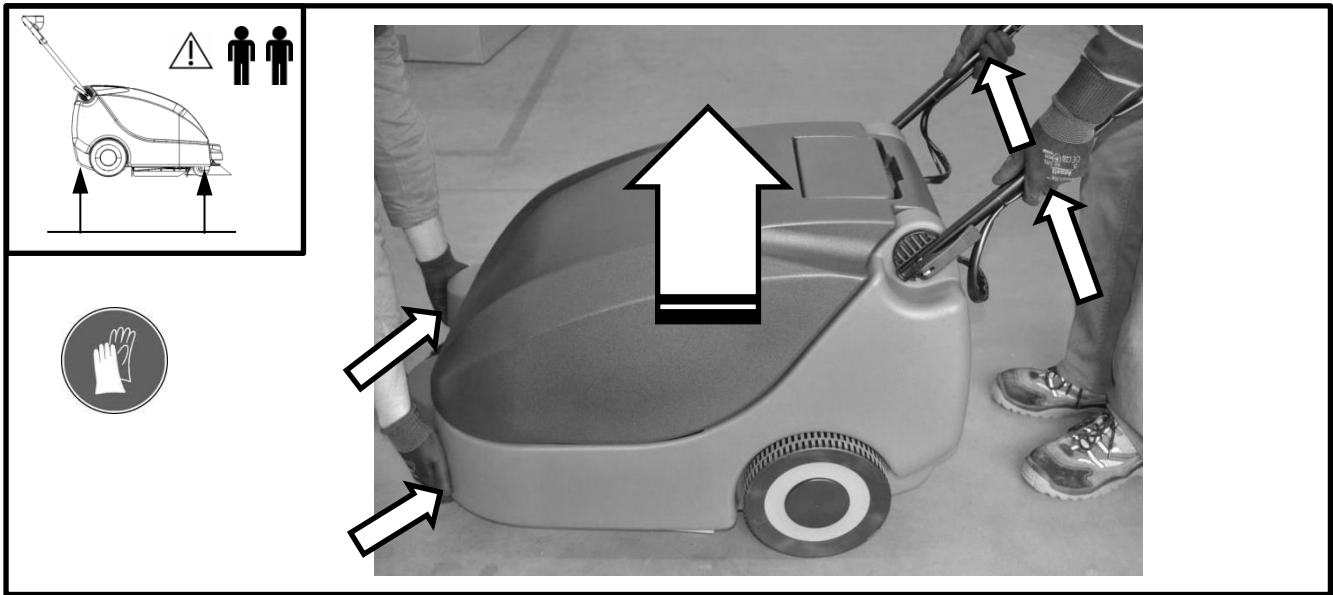
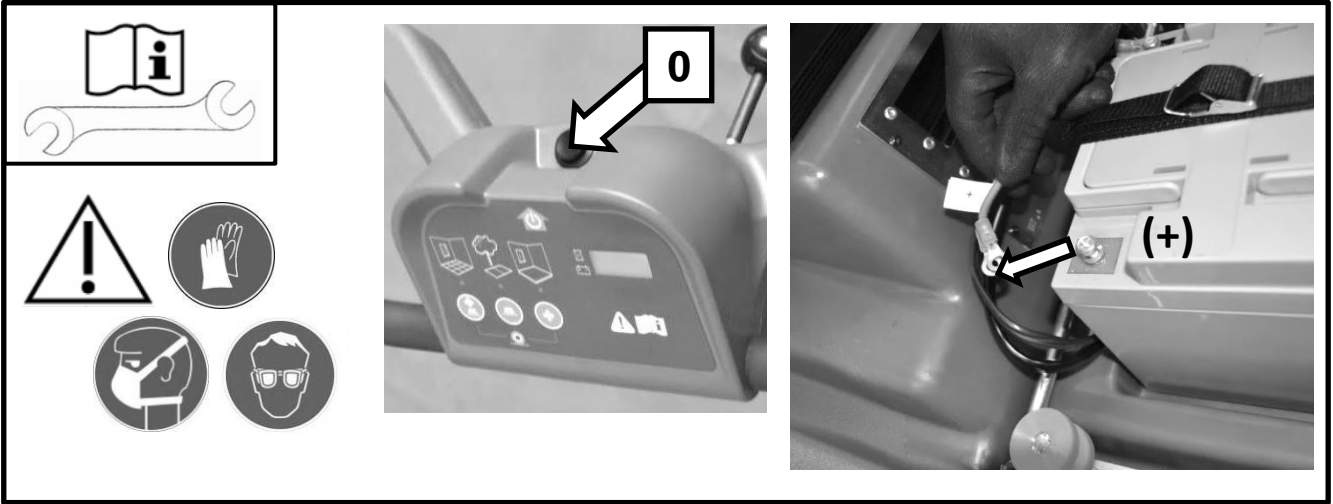

This section provides technical specifications for the power equipment. On the left, a close-up photograph shows a label on the machine with an arrow pointing to the specifications table. The table lists the following information:

POWER EQUIPMENT			
Walk Behind Sweeper			
MODEL:	XX	POWER:	230 W
MATERIAL NO.:	XXXXXXX	VOLTAGE:	12 V
SERIAL NUMBER:	XX XXX XXX	CURRENT:	12,6 A
DC:	XXXX	WEIGHT-NET :	40 kg
PROTECTION:	IPX3	WEIGHT- WITH BATTERY:	55 kg
TENNANT COMPANY		SOUND PRESSURE:	62 dB
701 North Lilac Drive		2%	
R.O. Box 1452		Made in Germany	
Minneapolis, MN 55440 USA			
1-800-553-8033			
www.tennantco.com			

Electrical Diagram

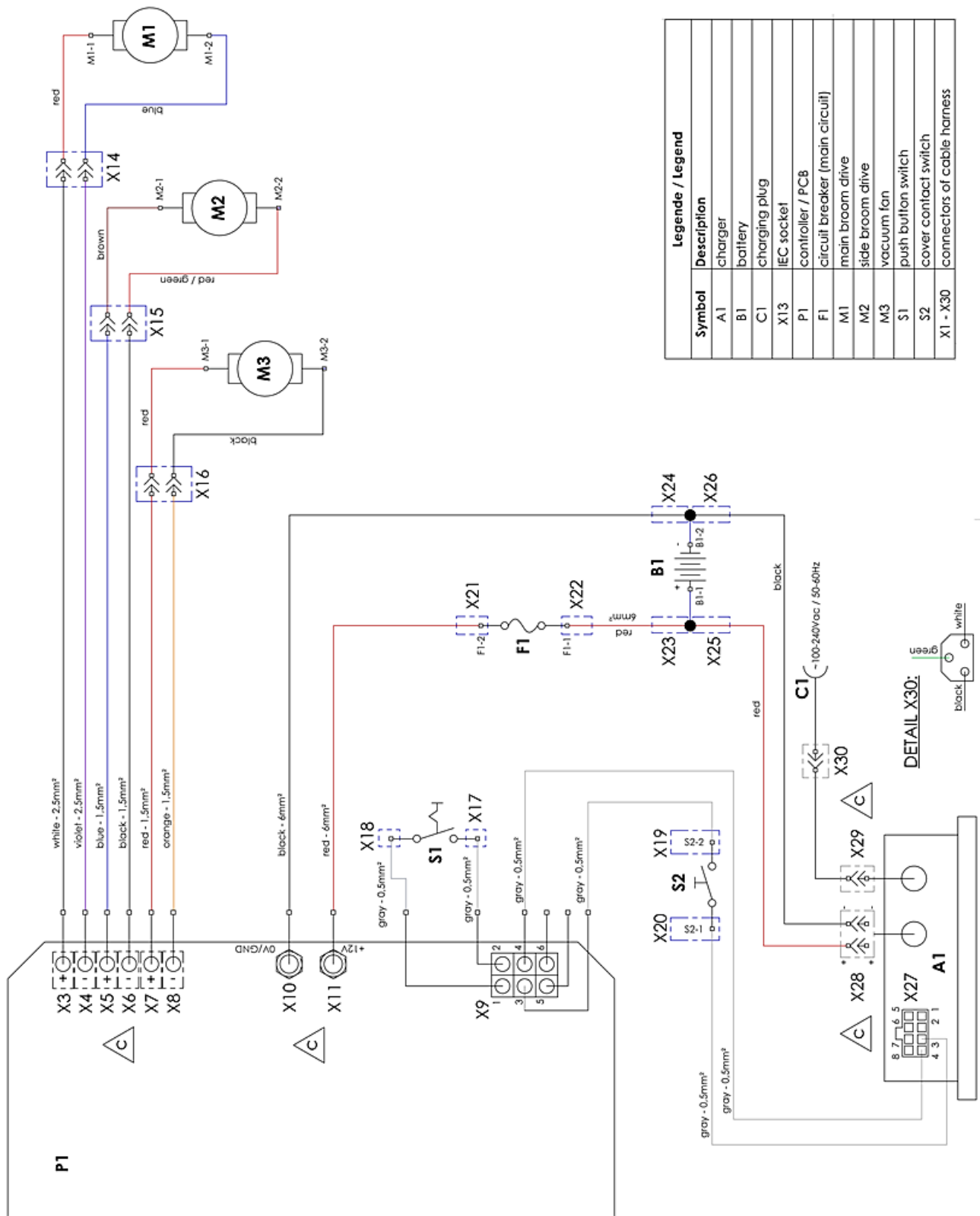

Legende / Legend	
Symbol	Description
A1	charger
B1	battery
C1	charging plug
X13	IEC socket
P1	controller / PCB
F1	circuit breaker (main circuit)
M1	main broom drive
M2	side broom drive
M3	vacuum fan
S1	push button switch
S2	cover contact switch
X1 - X30	connectors of cable harness

Fig. 1 – Wheel, Caster and Main Brush Assy

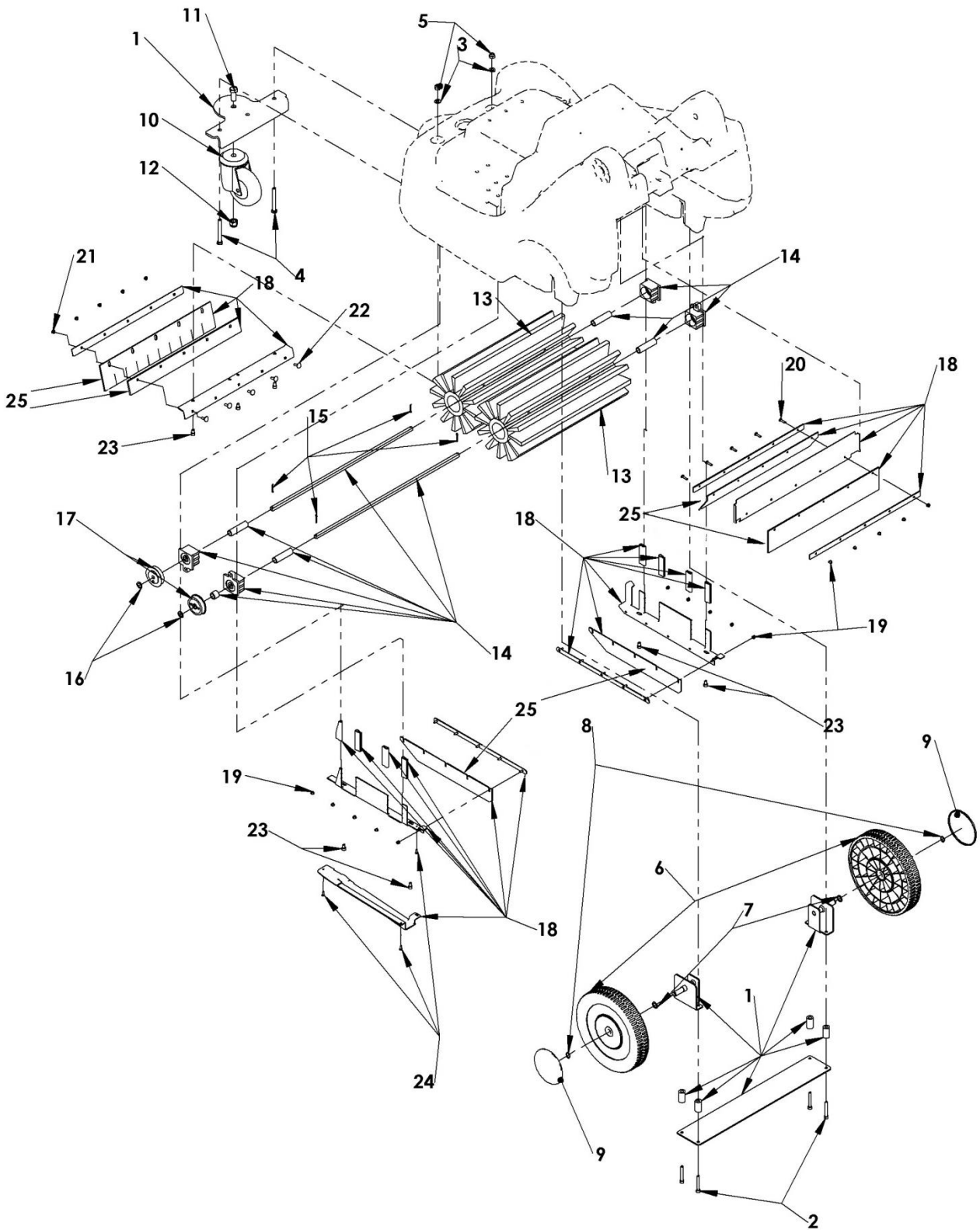

Fig. 1 – Wheel, Caster and Main Brush Assy

Ref.	Part No.	Description	Qty.	
▽	1	9010079	Wheel MTG Kit (Includes Wheel Bracket Qty2, Bracket Qty1, Caster Bracket Qty1, Bushings Qty4 & Mounting Hardware)	1
▲	2	N/A	Screw, Soc, M6x1x45	4
▲	3	N/A	Washer, Flat M8	2
▲	4	N/A	Screw, Hex, M8x1.25x70	2
▲	5	N/A	Nut, Hex, Lock, M8	2
▽	6	9010054	● Wheel Kit (Includes Wheel Qty1 & Mounting Hardware)	2
▲	7	N/A	Washer, Flat M12x18x1	2
▲	8	N/A	Locking Ring D=12	2
	9	9010056	● Hub Cap Kit (Includes Hub Cap Qty2)	1
▽	10	9010058	● Caster Kit	1
▲	11	N/A	Screw, Hex, M12x1.75x30	1
▲	12	N/A	Nut, Hex, Lock, M12	1
	13	9010035	● Brush Kit (Includes Brush Halves Qty2 & Mounting Hardware)	2
▽	14	9010177	Brush Axle Kit (Includes Front Axle Qty1, Rear Axle Qty1, Pipes Qty4, Bearings kpl Qty4 & Mounting Hardware)	1
▲	15	N/A	Cotter Pin 2.5x20	4
▲	16	N/A	Washer, Flat M12x18x1	2
	17	9010170	Pulley Kit Main Brush (Includes Pulley Z32 Qty2, Pulley Z60 Qty1, Double Pulley Z32 Qty1, Pulley Z20 & Mounting Hardware)	1
▽	18	9010037	● Brush Flap Kit (Includes Flaps Side Qty2, Front Qty2 and Rear Qty2, Brackets Qty10, Rubber Profiles Qty8 & Mounting Hardware) Note: Rubber Blades also included with Kit 9013450 (Pos. 25)	1
▲	19	N/A	Nut, Hex, Lock M4	15
▲	20	N/A	Screw, Hex, M4x0.7x16	5
▲	21	N/A	Nut, Hex, Lock M5	5
▲	22	N/A	Bolt, Carriage, M5x0.8x16	5
▲	23	N/A	Screw, Soc, M6x1x10	7
▲	24	N/A	Screw, Pan 3.5x13 TCUT	3
	25	9013450	● Brush Flap Rubber Blade Kit (Includes Flaps Side Qty2, Front Qty2 and Rear Qty2)	1

▽ ASSEMBLY

▲ INCLUDED IN ASSEMBLY

● RECOMMENDED STOCK ITEM

N/A Not Available Separately. Local Purchase.

Fig. 2 – Side and Main Brush Drive Assy

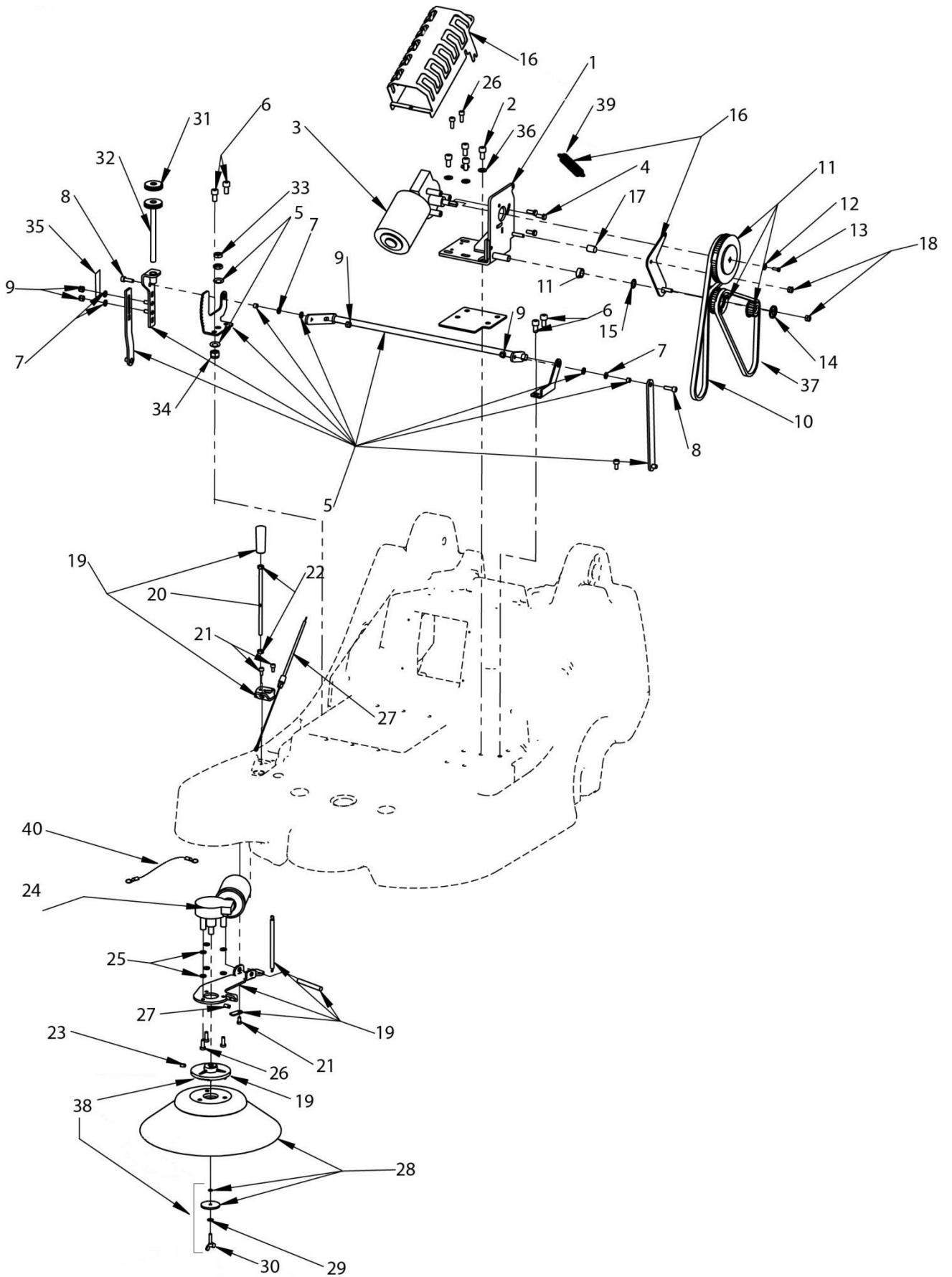

Fig. 2 – Side and Main Brush Drive Assy

Ref.	Part No.	Description	Qty.	
▽	1	9010173	Bucket Kit Fan Battery (Includes Brackets Batt Qty2, Bracket Fan Qty1, Bracket Shaker Qty1, Bracket Brush Motor Qty1, Motor Guard Qty1, Adjustment Plate Qty1, Strap Qty1 & Mounting Hardware)	1
▲	2	N/A	Screw, Soc, M8x1.25x16	4
▽	3	9010066	● Motor Kit Main Brush (Includes Main Brush Motor Qty1, & Mounting Hardware)	1
▲	4	N/A	Screw, Lock, M6x1x16	3
▽	5	9010172	Adjuster Kit Main Brush (Includes Adjustment Axle Qty1, Bracket lh Qty 1, Bracket rh Qty1, Adjuster Top Qty1, Adjuster Bottom Qty1, Lever Qty1 Bushing Qty2, Rubber disc Qty2 & Mounting Hardware)	1
▲	6	N/A	Screw, Soc, M8x1.25x16	4
▲	7	N/A	Washer, Flat M6	4
▲	8	N/A	Screw, Soc, M6x1x20	2
▲	9	N/A	Nut, Hex Lock, M6	4
	10	9013456	● Double Timing Belt 80cm	1
▽	11	9010170	Pulley Kit Main Brush (Includes Pulley Z32 Qty2, Pulley Z60 Qty1, Double Pulley Z32 Qty1, Pulley Z20 & Mounting Hardware)	1
▲	12	N/A	Washer, Flat M4	1
▲	13	N/A	Screw, Hex, M4x0.7x12	1
▲	14	N/A*	Retainment ring D=12	1
▲	15	N/A	Washer, flat, 12x18x1	1
▽	16	9010171	Tensioner Kit, Brush Belt (Includes Tensioner Lever Qty1, Spring Qty1 & Mounting Hardware)	1
▲	17	N/A	Spacer 18x6.4x12	1
▲	18	N/A	Nut, Hex, Lock, M6	2
▽	19	9010194	Side Brush Bracket Kit (Includes Motor Bracket Qty1, Axle Qty1, Axle Bracket Qty1, Side Brush Flange Qty1, Spring Qty1, Conical Head Qty1 & Mounting Hardware)	1
▲	20	N/A	Threaded Bolt M6x1x160	1
▲	21	N/A	Screw, Soc M5x0.8x10	5
▲	22	N/A	Nut, Hex,Std, M6	2
▲	23	N/A	Screw, Headless, M6x1x10	1
▽	24	9010067	● Motor Kit Side Brush(Includes Gear Motor Qty1, & Mounting Hardware)	1
▲	25	N/A	Washer, Flat M6	6
▲	26	N/A	Screw, Soc, M6x1x16	3
	27	9013452	● Side Brush Lift Cable Kit (Includes, Side Cable Qty1 & Mounting Hardware)	1
▽	28	9010039	● Side Brush Kit (Includes Side Brush Qt1 & Mounting Hardware)	1
▲	29	N/A	Washer Lock, M5	1
▲	30	N/A	Wing Screw, M5x0.8x20	1
▽	31	9010011	● Knob Kit (Includes Black Balls M8 Qty 2, Yellow Balls M8 Qty 1, Knurled Knob M10 Qty 2, Knurled Knob M6 Qty 1 & Mounting Material)	1
▲	32	N/A	Screw, Hex, M10x1.5x100	1
▲	33	N/A	Nut, Hex, Std, M10	2
▲	34	N/A	Nut, Hex , Lock, M10	1
	35	9010104	● Label Kit (Includes Nobles Logo Qty 1, Label Scout 5 Qty 2, Label Warning NA Qty 1, Label Main Brush Qty 1, Label Shaker Qty 1)	1
▲	36	N/A	Washer, Flat M8	4
	37	9013457	● Timing Belt 60cm	2
	38	9013031	Side Brush Hub Kit (Includes Side Brush Flange Qty1 & Mounting Hardware)	1
	39	N/A*	Spring, Tensioner, Brush belt	1
	40	9014771	Wire, Ground, Static Kit [S5]	1

▽ ASSEMBLY

▲ INCLUDED IN ASSEMBLY

● RECOMMENDED STOCK ITEM

N/A Not Available Separately. Local Purchase.

N/A* Part included in hardware kit 9013076 (see page 36)

Fig. 3 – Cover, Filter and Electrical Assy

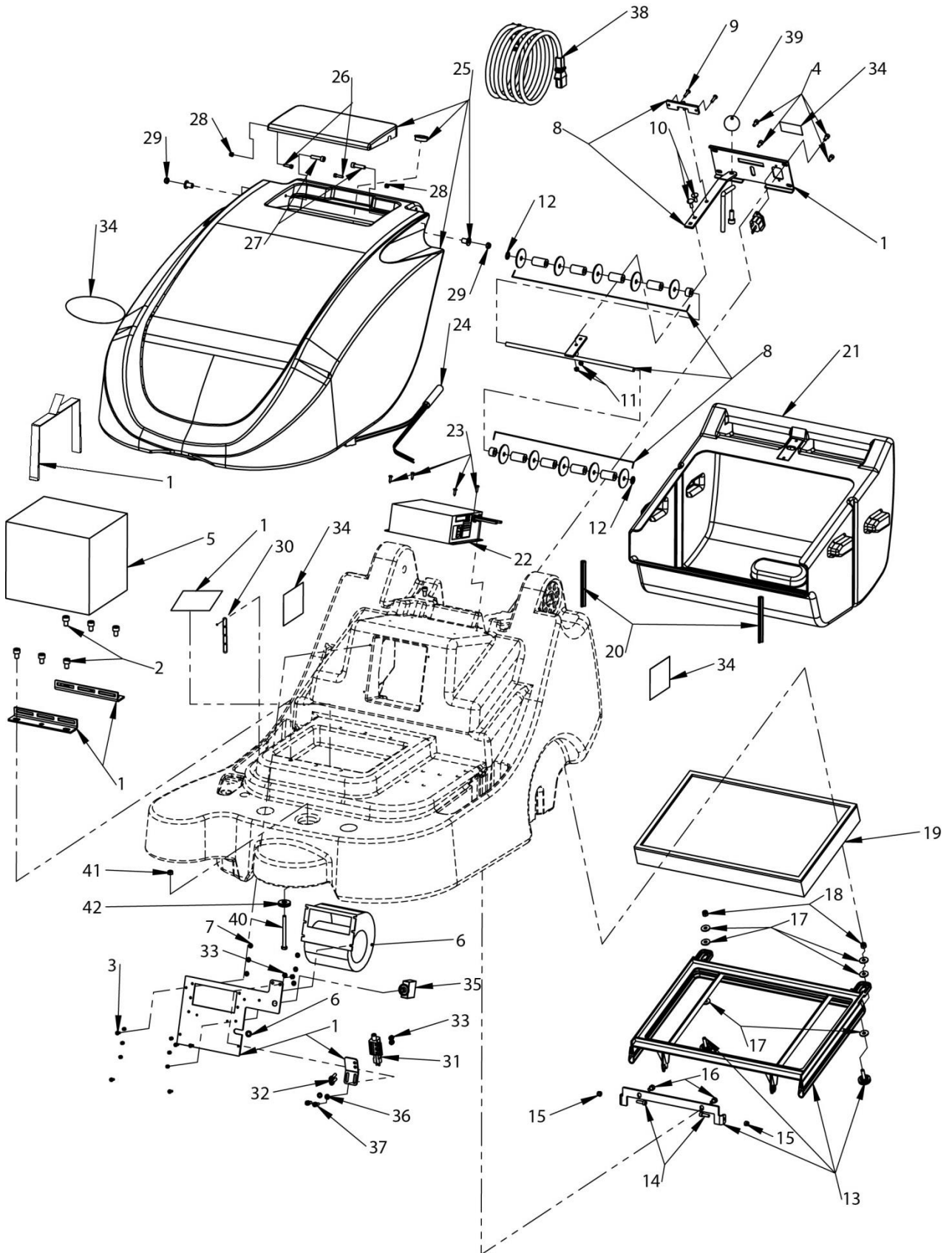

Fig. 3 – Cover, Filter and Electrical Assy

Ref.	Part No.	Description	Qty.	
▽	1	9010173	Bracket Kit Fan Battery (Includes Brackets Batt Qty2, Bracket Fan Qty1, Bracket Shaker Qty1, Bracket Brush Motor Qty1, Switch Bracket Qty1, Strap Qty1, Rubber Mat Qty1 & Mounting Hardware)	1
▲	2	N/A	Screw, Soc M8x1,25x10	6
▲	3	N/A	Screw, Pan, 3,5x13 TCUT	
▲	4	N/A	Screw, Soc M5x0.8x10	4
	5	1065086 ●	Battery Kit (Includes Battery Qty1)	1
▽	6	9010064 ●	Fan Blower Kit (Includes Fan Qty1, Grommet Qty1 & Mounting Hardware)	1
▲	7	N/A	Washer, Flat, M4	6
▽	8	9010061	Shaker Kit (Includes Bracket Qty1, Lever Qty1, Axle Qty1, Bushing Qty2, Bushing Qty8, Rubber Disc Qty10, Lever Qty1 & Mounting Hardware)	1
▲	9	N/A	Screw, Pan, 4x20 TCUT	2
▲	10	N/A	Bolt Carriage, M5x0.8x16	2
▲	11	N/A	Nut, Hex, Lock, M5	2
▲	12	N/A*	Retainment Ring D=8	2
▽	13	9010192	Filter Holder Kit (Includes Filter Frame Qty1, Frame Bracket Qty1, Knurled Screw Qty2)	1
▲	14	N/A	Screw, Soc M5x0.8x16	2
▲	15	N/A	Nut, Hex, Lock, M5	4
▲	16	N/A	Screw, Soc M6x1x10	2
▲	17	N/A	Washer, Flat M6	6
▲	18	N/A	Nut, Hex, Lock, M6	2
	19	9010041 ●	Filter Kit (Includes Filter Qty1)	1
	20	9010043 ●	Hopper Seal Kit (Includes Seal Qty2)	1
	21	9010030	Hopper Kit (Includes Hopper Qty1)	1
▽	22	9010047 ●	Charger Kit (Includes Charger Qty1 & Mounting Hardware)	1
▲	23	N/A	Screw, Pan, 3,5x13 TCUT	4
	24	9010051	Wire Harness Kit (Harness Qty1)	1
▽	25	9010135	Front Cover Kit NG (Includes Front Cover NG Qty1, Flap Qty 1, Plug Qty 1, Sleeve Qty 2, Knurled Knob Qty 1 & Mounting Hardware)	1
▲	26	N/A	Screw, Soc, M4x0.7x16	2
▲	27	N/A	Screw, Soc, M6x0.8x26	2
▲	28	N/A	Nut, Hex, Lock, M4	2
▲	29	N/A	Nut, Hex, Lock, M6	2
	30	9009647 ●	Strap Kit, Static	1
▽	31	9010046 ●	Safety Switch Kit (Includes Switch Qty1, & Mounting Hardware)	1
▲	32	N/A	Screw, Soc M5x0.8x16	2
▲	33	N/A	Nut, Hex, Lock, M5	2
	34	9010104 ●	Label Kit (Includes Nobles Logo Qty 1, Label Scout 5 Qty 2, Label Warning NA Qty 1, Label Main Brush Qty 1, Label Shaker Qty 1)	1
	35	9010417	Circuit Breaker Kit (Includes Circuit Breaker 25A)	1

▽ ASSEMBLY

▲ INCLUDED IN ASSEMBLY

● RECOMMENDED STOCK ITEM

N/A Not Available Separately. Local Purchase.

N/A* Part included in hardware kit 9013076 (see page 36)

Fig. 3 – Cover, Filter and Electrical Assy

Ref.	Part No.	Description	Qty.	
▲	36	N/A	Screw, Soc M5x0.8x12	2
▲	37	N/A	Washer, flat M5	2
	38	1044067 ●	Cord, Power, 16/3 BLK [2,5meter, US]	1
	39	9010011 ●	Knob Kit (Includes Black Balls M8 Qty 2, Yellow Balls M8 Qty 1, Knurled Knob M10 Qty 2, Knurled Knob M6 Qty 1 & Mounting Material)	1
	40	N/A	Screw, Hex, M6x1x65 (Included with item 25)	1
	41	N/A	Nut, Hex, Lock, M6 (Included with item 25)	1
	42	N/A	Knob, Knurled, M6 (Included with Item 25)	1

Note: Knob also included with Knob Kit 9010011

- ▽ ASSEMBLY
- ▲ INCLUDED IN ASSEMBLY
- RECOMMENDED STOCK ITEM
- N/A Not Available Separately. Local Purchase.

Fig. 4 – Handle Assy

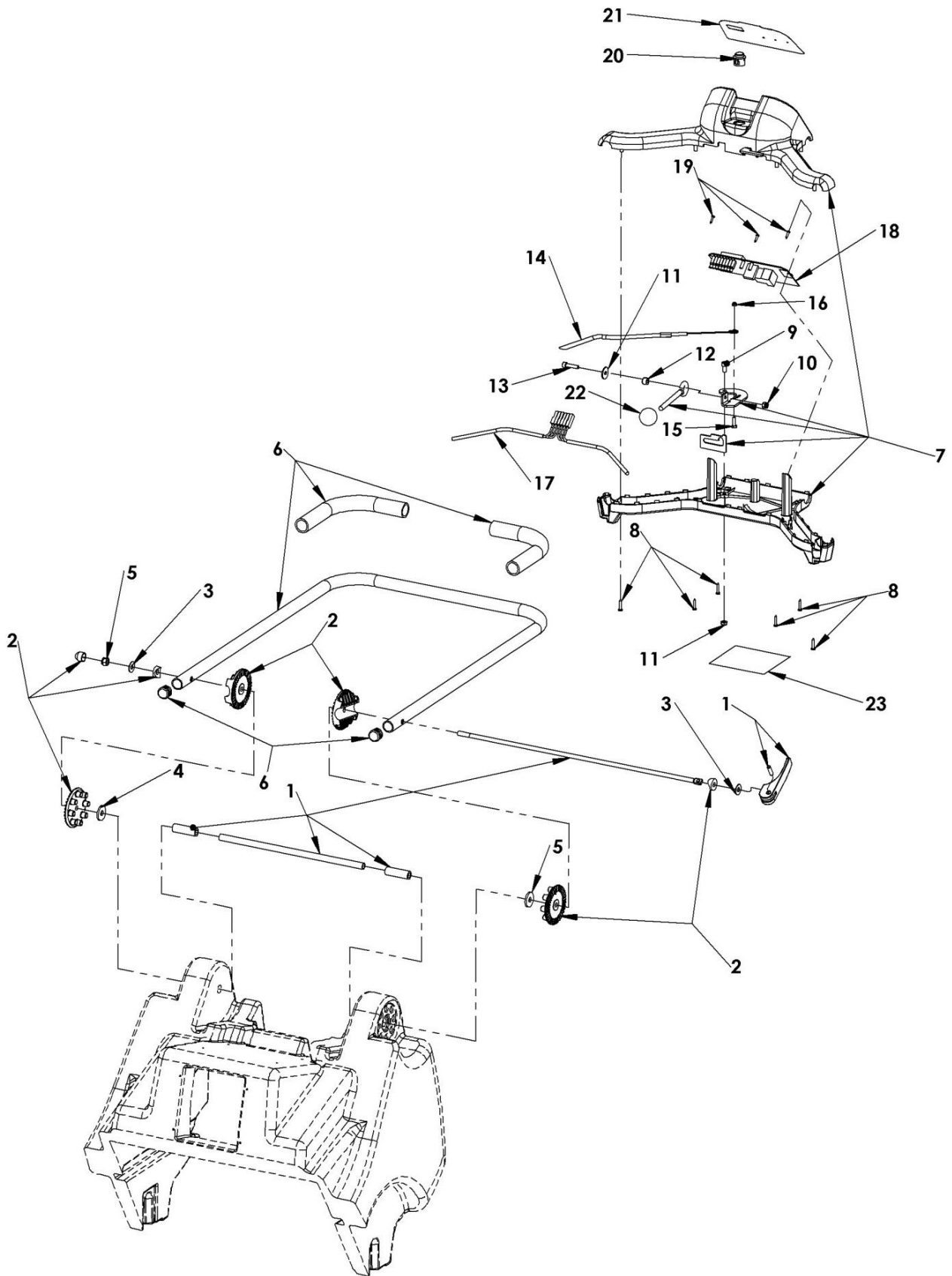

Fig. 4 – Handle Assy

Ref.	Part No.	Description	Qty.	
1	9010181	Handle Rod & Lever Kit (Includes Lever Qty 1, Pipe Long Qty1, Pipe Short Qty2, Rod Qty1 & Spring 6x22 Qty 1)	1	
▽	2	● Handle Hinge/Pivot Kit (Includes Hinge Outside Qty2, Hinge Inside Qty2, Plastic Disc Qty2, Cap Qty1 & Mounting Hardware)	1	
▲	3	N/A	Washer, Flat M8	2
▲	4	N/A	Washer, Flat M8x28	2
▲	5	N/A	Nut, Hex, Lock, M8	1
	6	9010032	Handle Kit (Includes Handle Qty1, Soft Gripp Qty2, Plugs Qty2)	1
▽	7	9010044	Inst Panel Kit (Includes Panel Top Qty1, Panel Bottom Qty1, Slotted Bracket Qty2, Adjuster Bracket lh Qty1, Adjuster Bracket rh Qty1, Eye Bolt Qty2 & Mounting Hardware)	1
▲	8	N/A	Screw, Pan 3.5x20 TCUT	6
▲	9	N/A	Screw, Soc M6x1x12	1
▲	10	N/A	Nut, Hex, Lock, M6	2
▲	11	N/A	Washer, Flat M6x22	1
▲	12	N/A	Sleeve M6	1
▲	13	N/A	Screw, Soc M6x1x20	1
▽	14	● 9013452	Side Brush Lift Cable Kit (Includes Side Cables Qty2, Side Cable Qty1 & Mounting Hardware)	1
▲	15	N/A	Screw, Hex, M5x0.8x16	1
▲	16	N/A	Nut, Hex, Lock, M5	1
	17	9010051	Wire Harness Kit (Includes Harness Qty1)	1
▽	18	● 9010050	Controlboard Kit (Includes Control Board Qty1 & Mounting Hardware)	1
▲	19	N/A	Screw, Pan, 2.9x13 TCUT	3
	20	● 9010174	Switch Kit Push Button (Includes Push Button Switch Qty1)	1
	21	1071274	Inst Panel Label	1
	22	● 9010011	Knob Kit (Includes Black Balls M8 Qty 2, Yellow Balls M8 Qty 1, Knurled Knob M10 Qty 2, Knurled Knob M6 Qty 1 & Mounting Material)	1
	23	● 9010104	Label Kit (Includes Nobles Logo Qty 1, Label Scout 5 Qty 2, Label Warning NA Qty 1, Label Warning EU Qty 1, Label Main Brush Qty 1, Label Shaker Qty 1)	1

▽ ASSEMBLY

▲ INCLUDED IN ASSEMBLY

● RECOMMENDED STOCK ITEM

N/A Not Available Separately. Local Purchase.

Kit Content – Hardware Kit (Part No. 9013076)

Ref.	Part No.	Description	Qty.
1		Retainment ring D=8	10
2		Retainment ring 8mm, square	10
3		Retainment ring D=12	10
4		Spring, Tensioner, Brush Belt	1
5		Spring, Propel	1